



1988

BMW 325iX

Electrical

Troubleshooting

Manual

**BMW of North America, Inc.
Montvale, New Jersey**

FOREWORD

In the interests of continuing technical development work we reserve the right to modify designs and equipment.

Printed in USA

©Copyright BMW of North America, Inc.

Not to be reproduced wholly or in part
without written permission of BMW of
North America, Inc.

PN 01 00 1 467 827

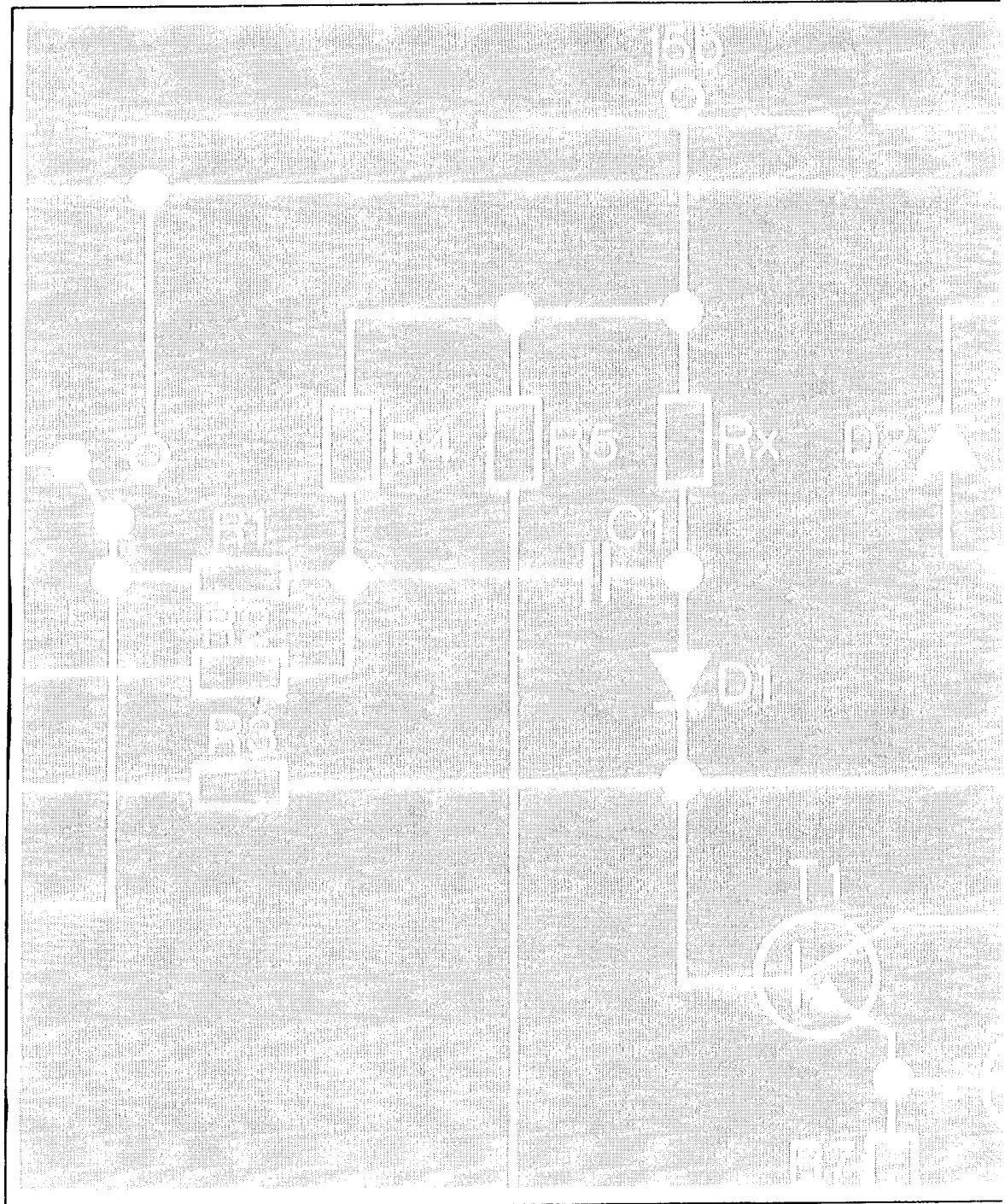

**1988
BMW 325iX
Electrical
Troubleshooting
Manual**

CONTENTS

Index	2
How To Use This Manual	3
Symbols	4
Wire Size Conversion Chart . . .	3
Systematic Troubleshooting . .	6
Connector Views	8500-0
Power Distribution Box	0670-0
Fuse Data	0670-1
Component Location Chart . . .	9000-0
Component Location Views . .	7000-0
Splice Location Views	8000-0

2 INDEX

Index – Alphabetical Listing of Electrical Circuits

	PAGE		PAGE		PAGE
Active Check Control	6216-0		0670-14	– Front Turn/Park	6314-0
A/C Air Delivery Control	6421-0		0670-15	– Glove Box	6100-1
A/C Blower Controls	6413-0	– G201	0670-14	– Hazard Switch	6313-0
A/C Compressor Controls	6452-0	– G300	0670-15	– Headlights	6312-0
A/C Temperature Control	6411-0	Heated Seats	5200-0	– Instrument Cluster	6300-1
Antilock Braking System (ABS)	3450-0	Horns	6100-0	– Interior	6330-0
Auto-Charging Flashlight	6100-1	Ignition Key Warning	6131-0	– License	6320-0
Auxiliary Fan	6454-0	Indicators		– Map Reading Light	6100-1
Auxiliary Fuse	0670-2	– Active Check Control Alarm	6210-1	– Park	6314-0
Brake Warning System	3435-0	– “Brake Lights” Fault	6216-1	– Rear Ashtray	6300-1
Central Locking	5126-0	– “Brake Lining” Wear	3435-0	– Rear Side Marker	6320-0
Charge	1230-0	– “Brake” Warning	3435-0	– Stop	6325-0
Cigar Lighter	6100-1	– Charge	6210-0	– Tail	6314-0
Component Location Chart	9000-0	– Check Engine	1360-7	– Trunk	6320-0
Component Location Views	7000-0	– “Coolant” Level Fault	6216-2	– Turn/Hazard	6313-1
Connector Views	8500-0	– “Engine Oil” Fault	6216-2	Light Switch Details	6300-0
Cruise Control	6571-0	– Fasten Seatbelts	6216-2	On-Board Computer	6581-2
Fuel Economy Gauge	6210-3	– Fog Lights	6312-0	Power Antenna	6500-0
Fuel Gauge	6210-1	– High Beam	6312-1	Power Distribution	0670-0
Fuse Data Chart	0670-1	– Inspection	6210-2	Power Distribution Box	0670-0
Fuse Details		– LH Turn	6313-1	Power Mirrors	5116-0
– Fuse 4	0670-6	– “License Plate” Fault	6320-0	Power Windows	5133-0
– Fuse 5	0670-6	– “Low Beam” Fault	6312-1	Radio With Sound System	6500-0
– Fuse 6	0670-6	– Low Fuel Warning	6210-1	Radio Without Sound System	6500-2
– Fuse 8	0670-7	– Oil Pressure Warning	6210-1	Rear Defogger	6100-2
– Fuse 9	0670-11	– Oil Service	6210-2	Seatbelt Warning	6131-0
– Fuse 10	0670-8	– “Park Brake”	3435-0	Service Interval Indicator	6210-2
– Fuse 12	0670-7	– “Rear Lights” Fault	6314-0	Speedometer	6210-0
– Fuse 19	0670-7	– RH Turn	6313-1	Splice Location Views Index	8000-0
– Fuse 20	0670-9	– “Washer Fluid” Fault	6216-2	Start	1240-0
– Fuse 21	0670-10	Injection Electronics	1360-0	Sunroof	5413-0
– Fuse 27	0670-11	Instrument Cluster	6210-0	Tachometer	6210-5
Gauges	6210-1	Lights		Temperature Gauge	6210-3
Ground Distribution		– A/C Control Power	6300-1	Warnings	
– G103	0670-12	– Back Up	6322-0	– Ignition Key/Seatbelt	6131-0
– G104	0670-12	– Fog	6312-0	Wiper/Washer	6160-0
– G106	0670-12	– Front Ashtray	6300-1		
– G200	0670-13	– Front Side Marker	6314-0		

The purpose of this manual is to show electrical schematics in a manner that makes electrical troubleshooting easier. Electrical components which work together are shown together on one schematic. The Wiper-Washer schematic, for example, shows all of the electrical components in one diagram. At the top of the page is the fuse (positive) that powers the circuit. The flow of current is shown through all wires, connectors, switches, and motors to ground (negative) at the bottom of the page.

Within the schematic, all switches and sensors are shown "at rest," as though the Ignition Switch were off. For identification, component names are underlined and placed next to or above each component. Notes are included, describing how switches and other components work.

The power distribution schematic shows the current feed through all the connections from the Battery and Alternator to each fuse and the Ignition and Light Switches. If the Power Distribution schematic is combined with any other circuit schematic, a complete picture is made of how that circuit works. The Ground Distribution schematics show how several circuits are connected to common grounds.

All wiring between components is shown exactly as it exists in the vehicle; however, the wiring is not drawn to scale. To aid in understanding electrical operation, wiring inside complicated components has been simplified. The "Solid State" label designates electronic components.

WIRE SIZE CONVERSION CHART	
METRIC (CROSSSECTIONAL AREA IN MM ²)	AWG (AMERICAN WIRE GAUGE)
.5	20
.75	18
1	16
1.5	14
2	14
2.5	12
4	10
6	8
8	8
16	4
20	4
25	2
32	2

WIRE INSULATION	
ABBREVIATIONS	COLOR
BK	BLACK
BR	BROWN
RD	RED
YL	YELLOW
GN	GREEN
BU	BLUE
VI	VIOLET
GY	GRAY
WT	WHITE
PK	PINK

4 SYMBOLS



ENTIRE COMPONENT SHOWN



PART OF A COMPONENT SHOWN

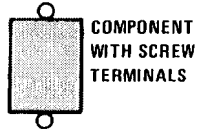

COMPONENT WITH SCREW TERMINALS

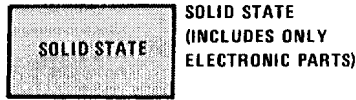

SOLID STATE (INCLUDES ONLY ELECTRONIC PARTS)

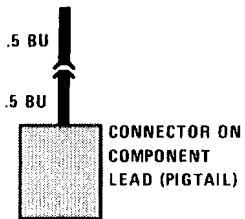

CONNECTOR ON COMPONENT LEAD (PIGTAIL)

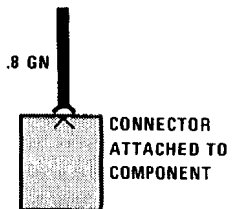

CONNECTOR ATTACHED TO COMPONENT

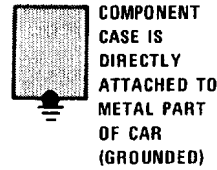

COMPONENT CASE IS DIRECTLY ATTACHED TO METAL PART OF CAR (GROUNDED)

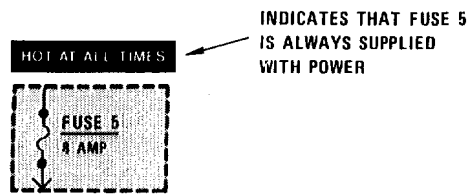

INDICATES THAT FUSE 5 IS ALWAYS SUPPLIED WITH POWER

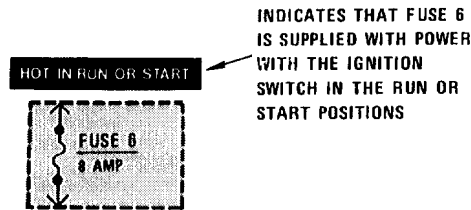

INDICATES THAT FUSE 6 IS SUPPLIED WITH POWER WITH THE IGNITION SWITCH IN THE RUN OR START POSITIONS

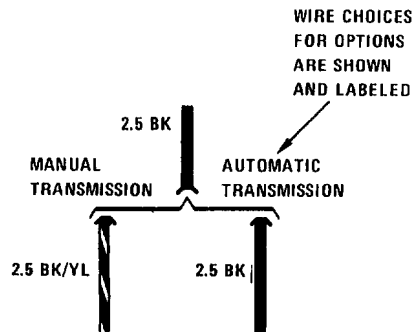

WIRE CHOICES FOR OPTIONS ARE SHOWN AND LABELED

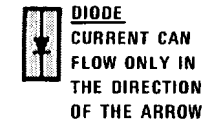
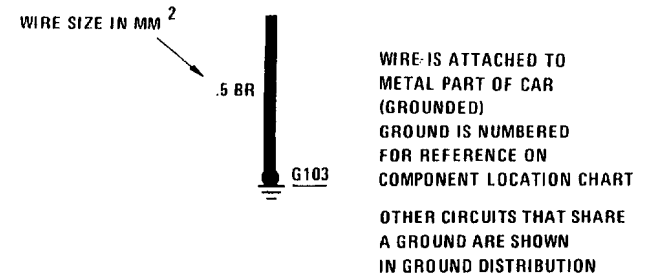
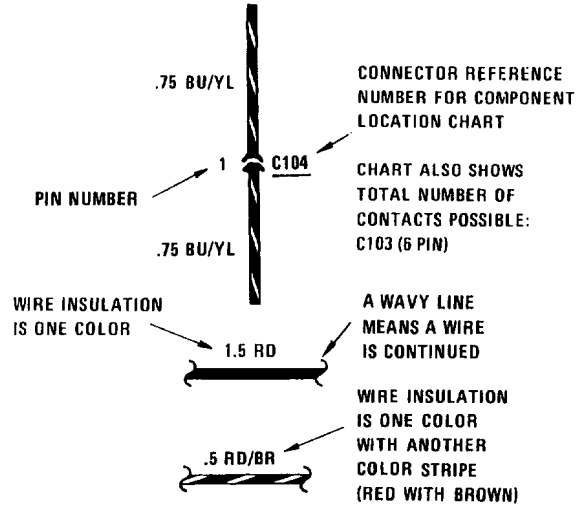

DIODE CURRENT CAN FLOW ONLY IN THE DIRECTION OF THE ARROW

CIRCUIT REFERENCE - A WIRE WHICH CONNECTS TO ANOTHER CIRCUIT



ACTIVE CHECK CONTROL



ONE POLE,
TWO POSITION
SWITCH

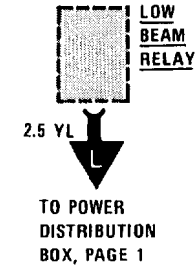
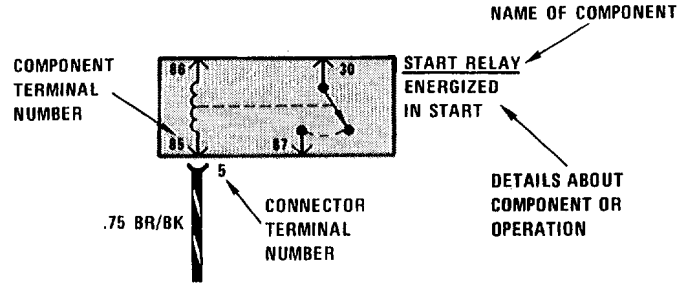

CURRENT PATH IS CONTINUED AS LABELED. THE ARROW SHOWS DIRECTION OF CURRENT FLOW AND IS REPEATED WHERE CURRENT PATH CONTINUES.

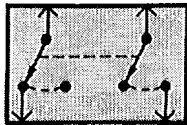

SWITCHES THAT MOVE TOGETHER
DASHED LINE SHOWS A MECHANICAL CONNECTION BETWEEN SWITCHES

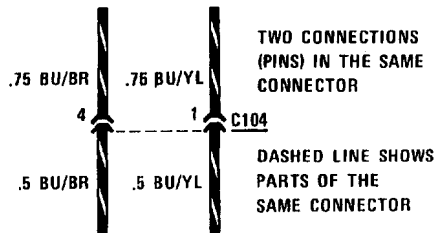
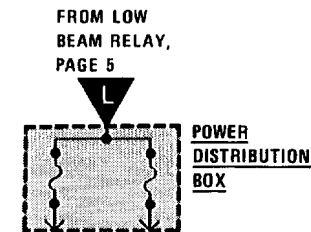
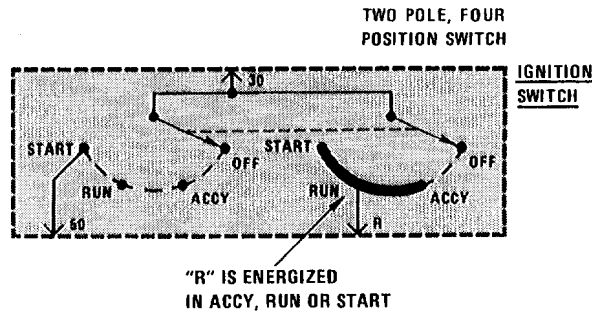

WHEN COIL IS ENERGIZED, SWITCH IS PULLED CLOSED

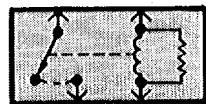

RELAY SHOWN WITH RESISTOR ACROSS COIL
RESISTOR ACROSS COIL IS FOR NOISE SUPPRESSION

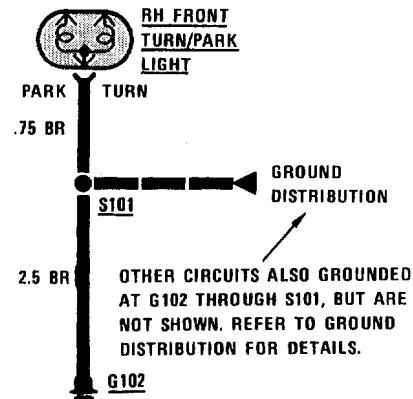

LIGHT EMITTING DIODE

6 SYSTEMATIC TROUBLESHOOTING

TROUBLESHOOTING PROCEDURE

1. Verify the Problem

Operate the problem circuit to check the accuracy of the complaint. Note the symptoms of the inoperative circuit.

2. Analyze the Problem

Refer to the schematic of the problem circuit in the ETM. Determine how the circuit is supposed to work by tracing the current path(s) from the power feed through the circuit components to ground. Then based on the symptoms you noted in step 1 and your understanding of circuit operation, identify one or more possible causes of the problem.

3. Isolate the Problem

Make circuit tests to prove or disprove the preliminary diagnosis made in step 2. Keep in mind that a logical simple procedure is the key to efficient troubleshooting. Test for the most likely cause of failure first. Try to make tests at points which are easily accessible.

4. Repair the Problem

Once the specific problem is identified, make the repair using the proper tools and safe procedures.

5. Check the Problem

Operate the circuit to check for satisfactory circuit operation. Good repair practice calls for rechecking all circuits you have worked on.

TROUBLESHOOTING TOOLS

Isolating the problem (Step 3 of TROUBLESHOOTING PROCEDURES) requires the use of a **voltmeter** and/or **ohmmeter**. A voltmeter measures voltage at selected points in a circuit. An ohmmeter measures a circuit's resistance to current flow. It has an internal battery that provides current to the circuit under test. Disconnect the car battery when using an ohmmeter because the battery voltage will cause the ohmmeter to give false readings. Also, do not use an ohmmeter on solid-state components. The voltage that the ohmmeter applies to the circuit could damage these components.

TROUBLESHOOTING TESTS

Voltage Test

This test measures voltage in a circuit. By taking measurements at several points (terminals or connectors) along the circuit, you can isolate the problem.

To take a voltage measurement, connect the negative lead of the voltmeter to the battery's negative terminal or other known good ground. Then connect the positive lead of the voltmeter to the point you want to test. The voltmeter will measure the voltage present at that point in the circuit.

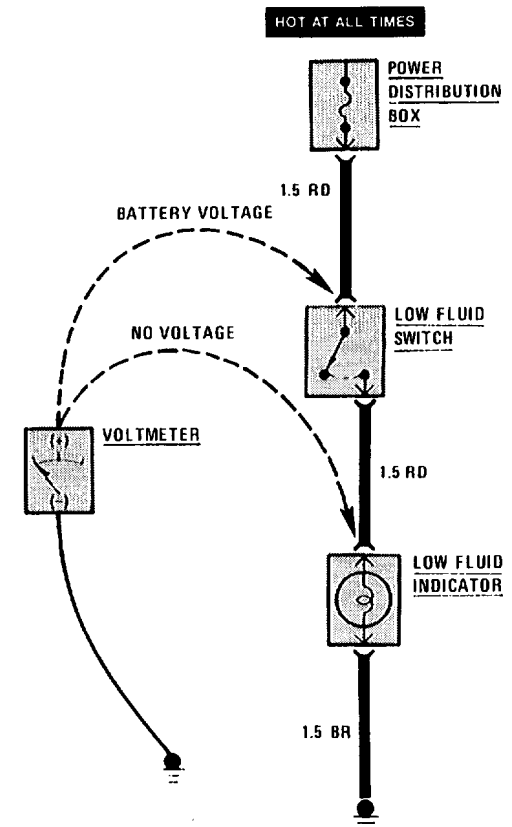

Voltage Test

Voltage Drop Test

Wires, connectors, and switches are designed to conduct current with a minimum loss of voltage. A voltage drop of more than one volt indicates a problem.

To test for voltage drop, connect the voltmeter leads to connectors at either end of the circuit's suspected problem area. The positive lead should be connected to the connector closest to the power source. The voltmeter will show the voltage drop between these two points.

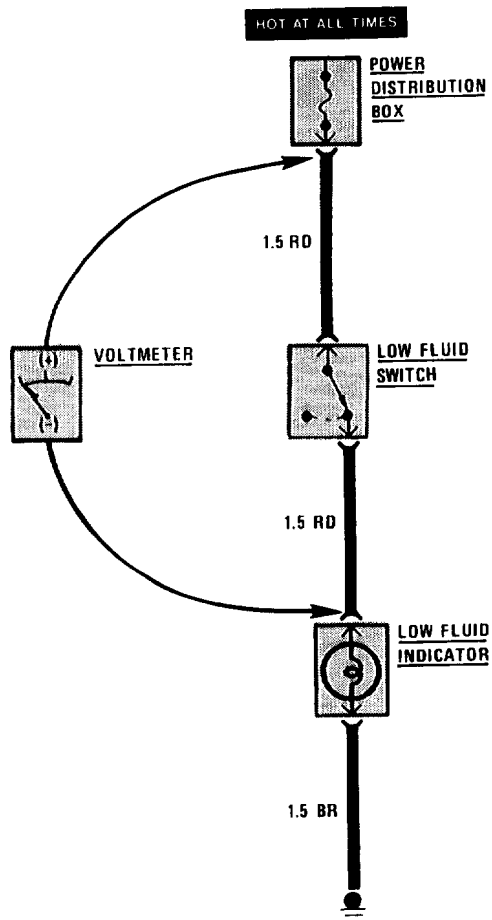

Voltage Drop Test

Continuity Test

To perform a continuity test, first disconnect the car battery. Then adjust the ohmmeter to read zero while holding the leads together. Connect the ohmmeter leads to connector or terminals at either end of the circuit's suspected problem area. The ohmmeter will show the resistance across that part of the circuit.

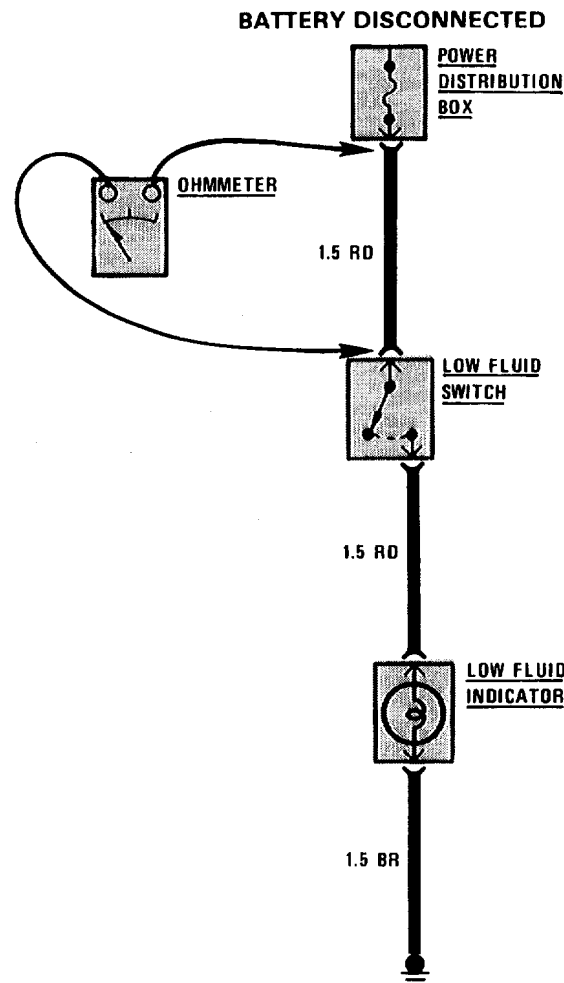

Continuity Test

Short Test Using Voltmeter

Remove the blown fuse and disconnect the load. Connect the voltmeter leads to the fuse terminals. The positive lead should be connected to the terminal closest to the power source.

Starting near the POWER DISTRIBUTION BOX, move the wire harness back and forth and watch the voltmeter reading. If the voltmeter registers a reading, there is a short to ground in the wiring. Somewhere in the area of the harness being moved, the wire insulation is worn away and the circuit is grounding.

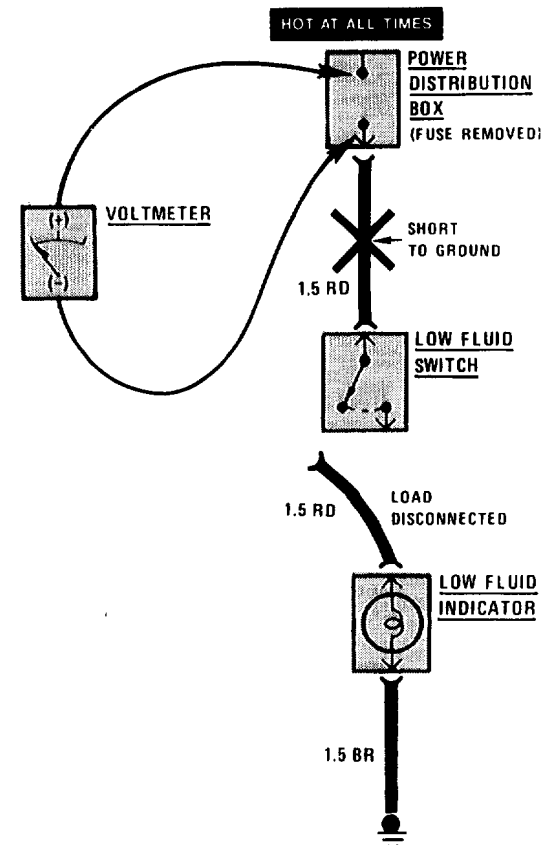

Short Test Using Voltmeter

8 SYSTEMATIC TROUBLESHOOTING

Short Test Using Ohmmeter

Disconnect the battery. Adjust the ohmmeter to read zero while holding the leads together. Remove the blown fuse and disconnect the load. Connect one lead of the ohmmeter to the fuse terminal that is closest to the load. Connect the other lead to a known good ground.

Starting near the POWER DISTRIBUTION BOX, move the wire harness back and forth and watch the ohmmeter reading. Low or no resistance indicates a short to ground in the wiring. Infinitely high resistance indicates no short.

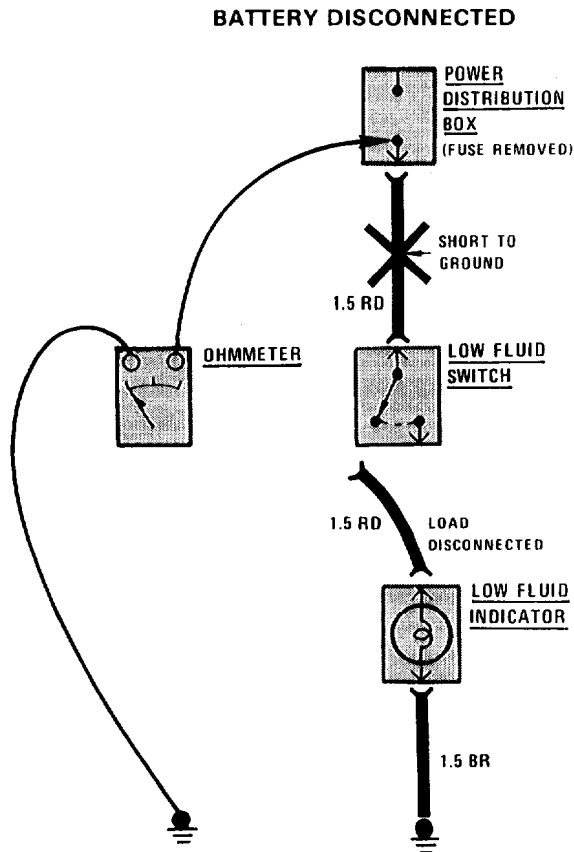

Short Test Using Ohmmeter

0670-0 POWER DISTRIBUTION

POWER DISTRIBUTION BOX

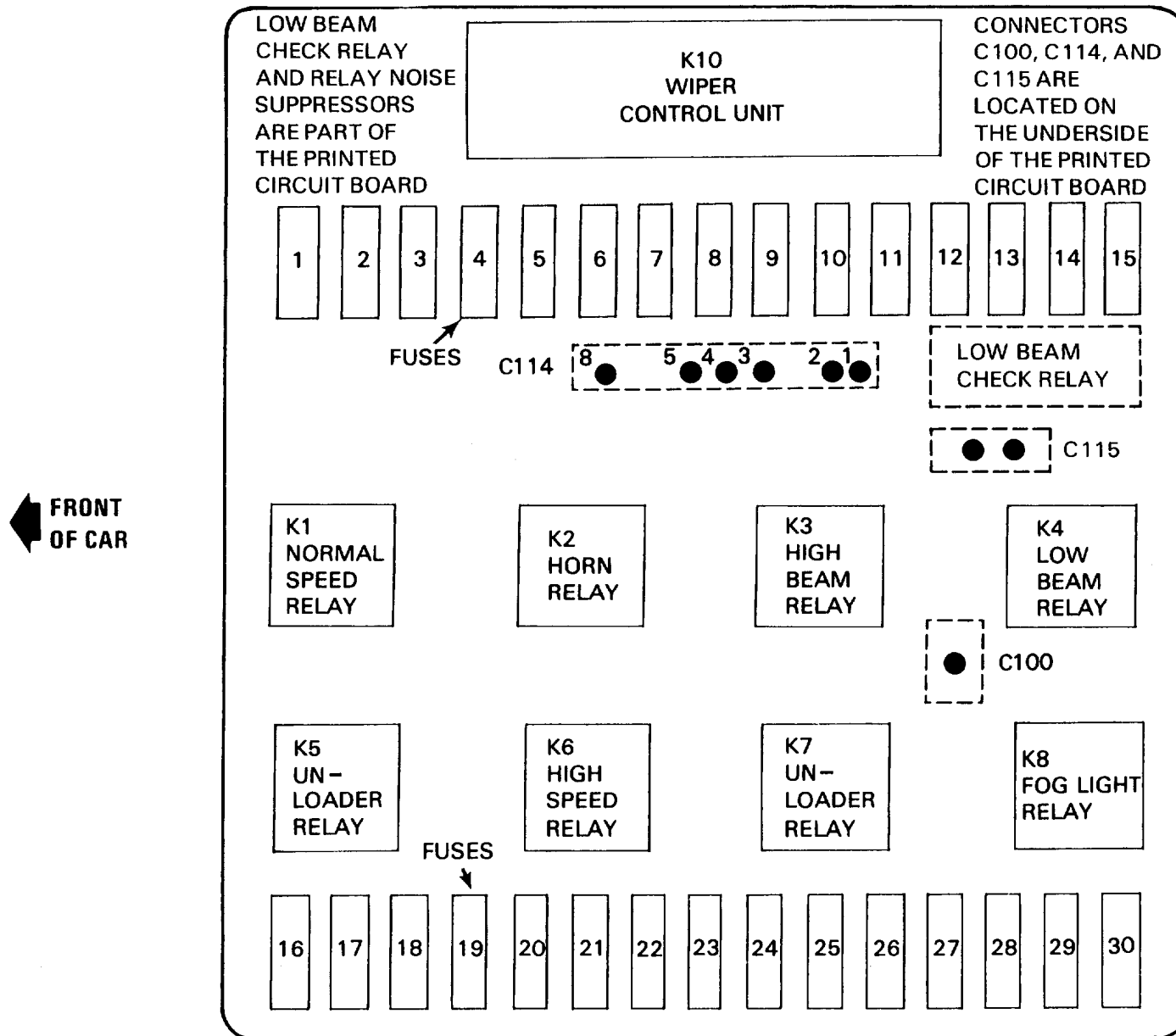

FUSE DATA CHART

FUSE NO.	SIZE	CIRCUIT NAME
1	7.5A	Headlights (also fuses 2, 13, 14); High Beam Indicator.
2	7.5A	Headlights (also fuses 1, 13, 14).
3	15A	Auxiliary Fan (also fuses 18, 19, 20).
4	15A	Lights: Turn/Hazard Warning (also fuse 24); Active Check Control (also fuses 6, 10, 21, 22, 23).
5	30A	Wiper/Washer.
6	7.5A	Stop Lights/Cruise Control Active Check Control (also fuses 4, 10, 21, 22, 23); Antilock Braking System; Interior Lights (also fuses 19, 21, 27); Map Reading Light.
7	15A	Horn.
8	30A	Rear Defogger (also fuse 23).
9	15A	Idle Speed Control.
10	7.5A	Seatbelt Warning (also fuse 21); Service Interval Indicator (also fuse 21); Tachometer/Fuel Economy Gauges (also fuse 21); Gauges/Indicators; Brake Warning System; Back Up Lights; On-Board Computer (also fuses 12, 21, 23, 27); Start; Active Check Control (also fuses 4, 6, 21, 22, 23); Injection Electronics (also fuses 9, 11, 21);
11	7.5A	Fuel Delivery; Injection Electronics (also fuses 9, 10, 21).
12	7.5A	Radio (also fuses 21, 27, 28); Speedometer/Indicators; On-Board Computer (also fuses 10, 21, 23, 27).
13	7.5A	Headlights (also fuses 1, 2, 14).
14	7.5A	Headlights (also fuses 1, 2, 13).
15		Not Used.
16	15A	Heated Seats.
17	30A	Sunroof; Power Windows.
18	30A	Auxiliary Fan (also fuses 3, 19, 20).
19	7.5A	Auxiliary Fan (also fuses 3, 18, 20); Interior Lights (also fuses 21, 27); Power Mirrors.

FUSE NO.	SIZE	CIRCUIT NAME
20	30A	Heater/Air Conditioning; Auxiliary Fan (also fuses 3, 18, 19).
21	7.5A	Auto-Charging Flashlight; Glove Box Light; Ignition Key Warning/Seatbelt Warning (also fuse 10); Interior Lights (also fuses 6, 19, 27); Radio (also fuses 12, 27, 28) Trunk Light; Active Check Control (also fuses 4, 6, 10, 22, 23); Service Interval Indicator (also fuse 10); On-Board Computer (also fuses 10, 12, 23, 27); Injection Electronics (also fuses 9, 10, 11); Tachometer/Fuel Economy Gauge (also fuse 10).
22	7.5A	Active Check Control (also fuses 4, 6, 10, 21, 23); Lights: Front Park/Tail (also fuse 23); Lights: Front Side Marker (also fuse 23).
23	7.5A	Lights: Dash Lights: Front Park/Tail (also fuse 22); Lights: Front Side Marker (also fuse 22); Lights: Rear Marker/License; Active Check Control (also fuses 4, 6, 10, 21, & 22); On-Board Computer (also fuses 10, 12, 21, 27); Rear Defogger (also fuse 8).
24	15A	Lights: Turn/Hazard Warning (also fuse 4).
25		Not Used.
26		Not Used.
27	30A	Interior Lights (also fuses 6, 19, 21); Central Locking; Radio/Antenna (also fuses 12, 21, 28); On-Board Computer (also fuses 10, 12, 21, 23).
28	30A	Cigar Lighter; Radio/Antenna (also fuses 12, 21, 27).
29	7.5A	Fog Lights (also fuse 30); Fog Light Indicator
30	7.5A	Fog Lights (also fuse 29).
POWER WINDOW CIRCUIT BREAKER		25A Power Windows

0670-2 POWER DISTRIBUTION

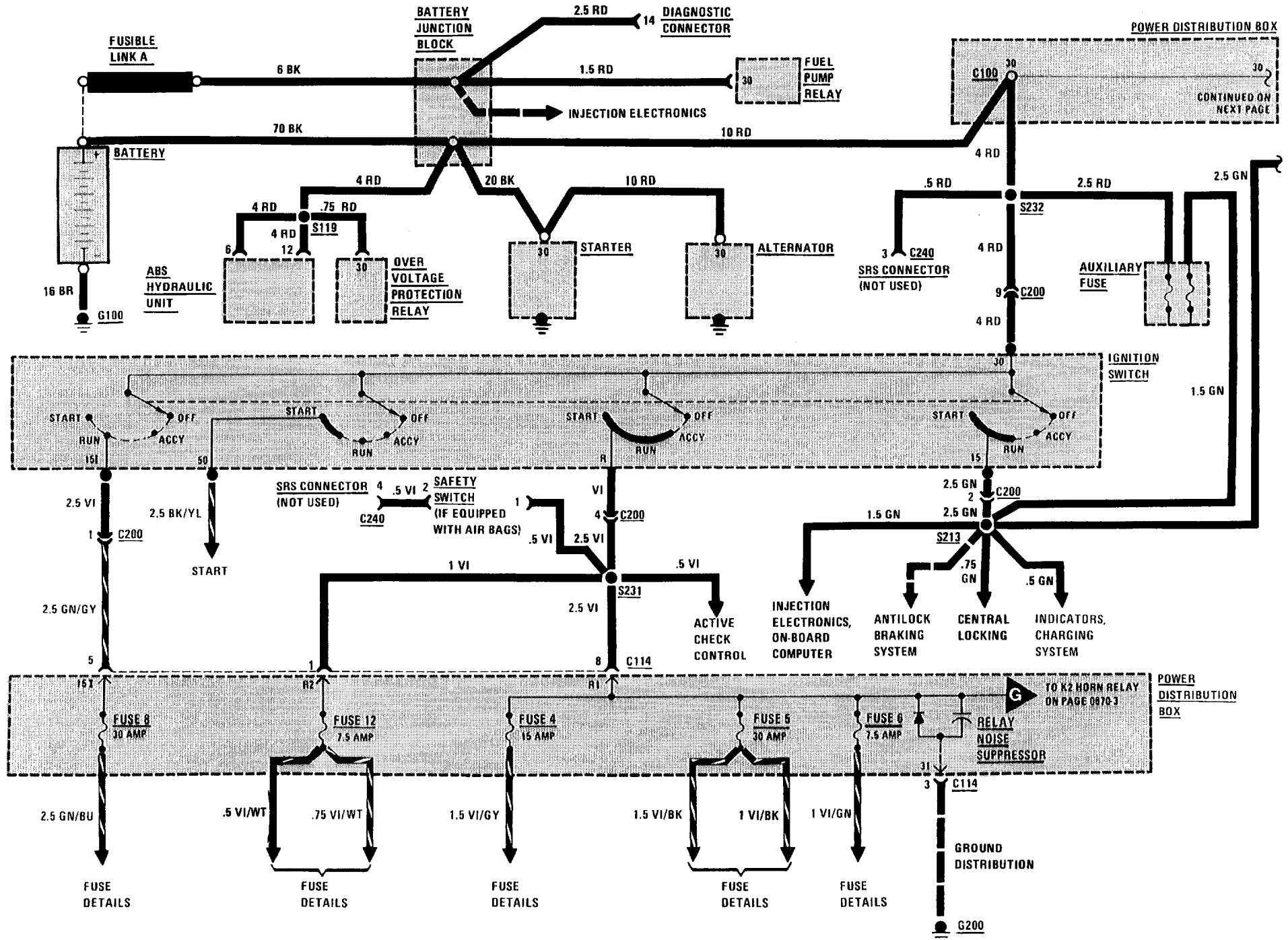

POWER DISTRIBUTION BOX

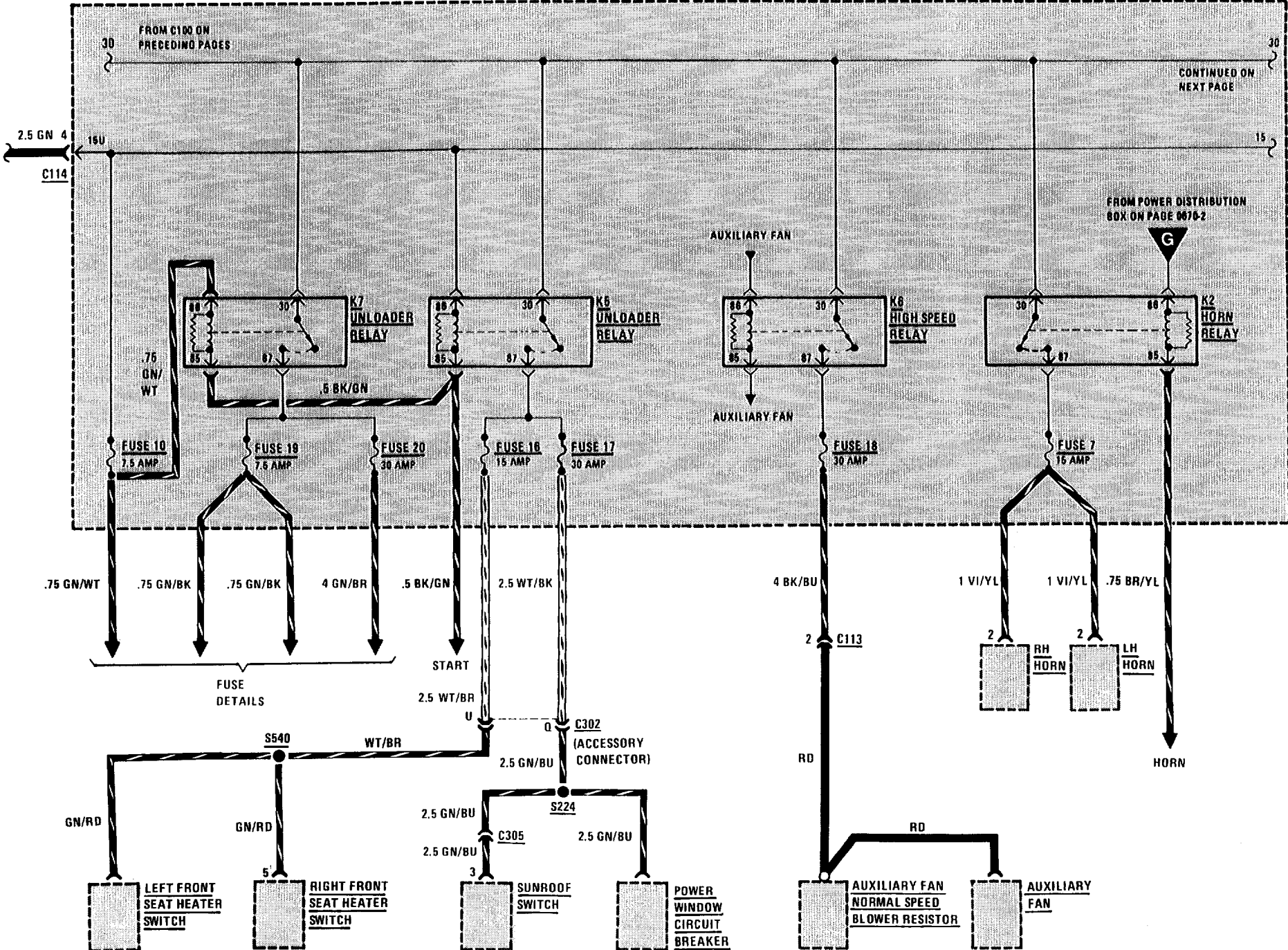

0670-4 POWER DISTRIBUTION

POWER DISTRIBUTION BOX

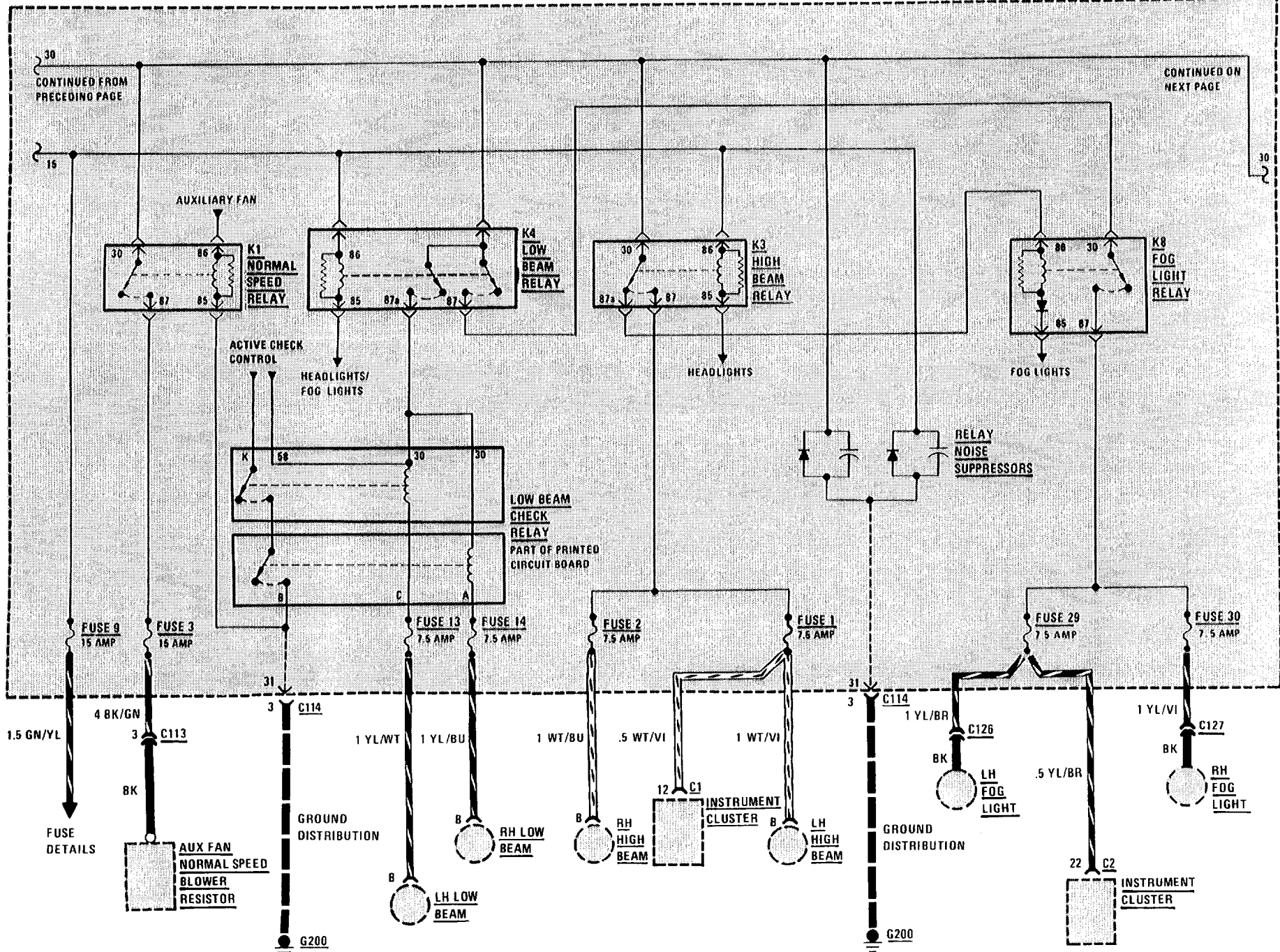

0670-6 POWER DISTRIBUTION

FUSE DETAILS: FUSES 4, 5, AND 6

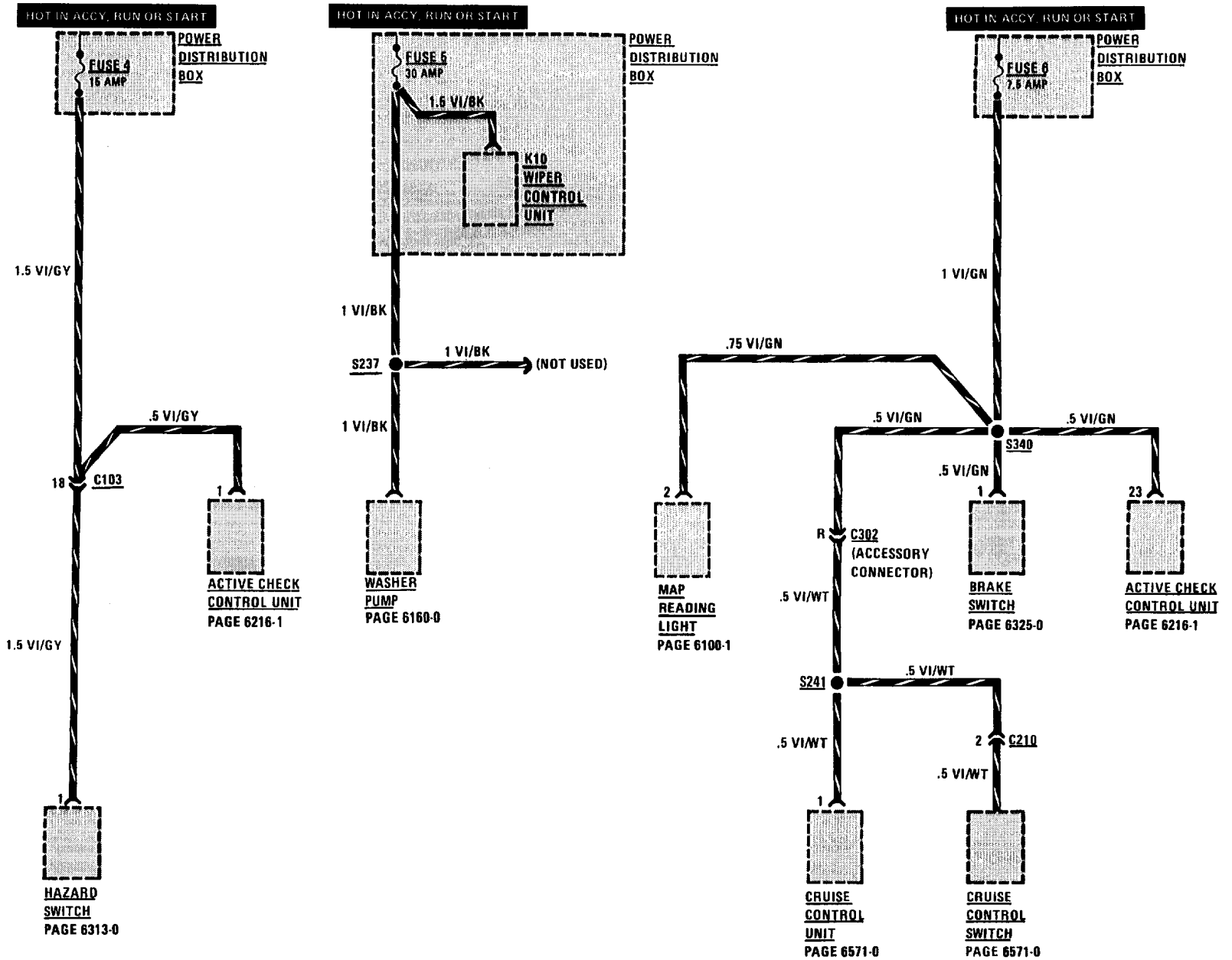

FUSE DETAILS: FUSES 8, 12 AND 19

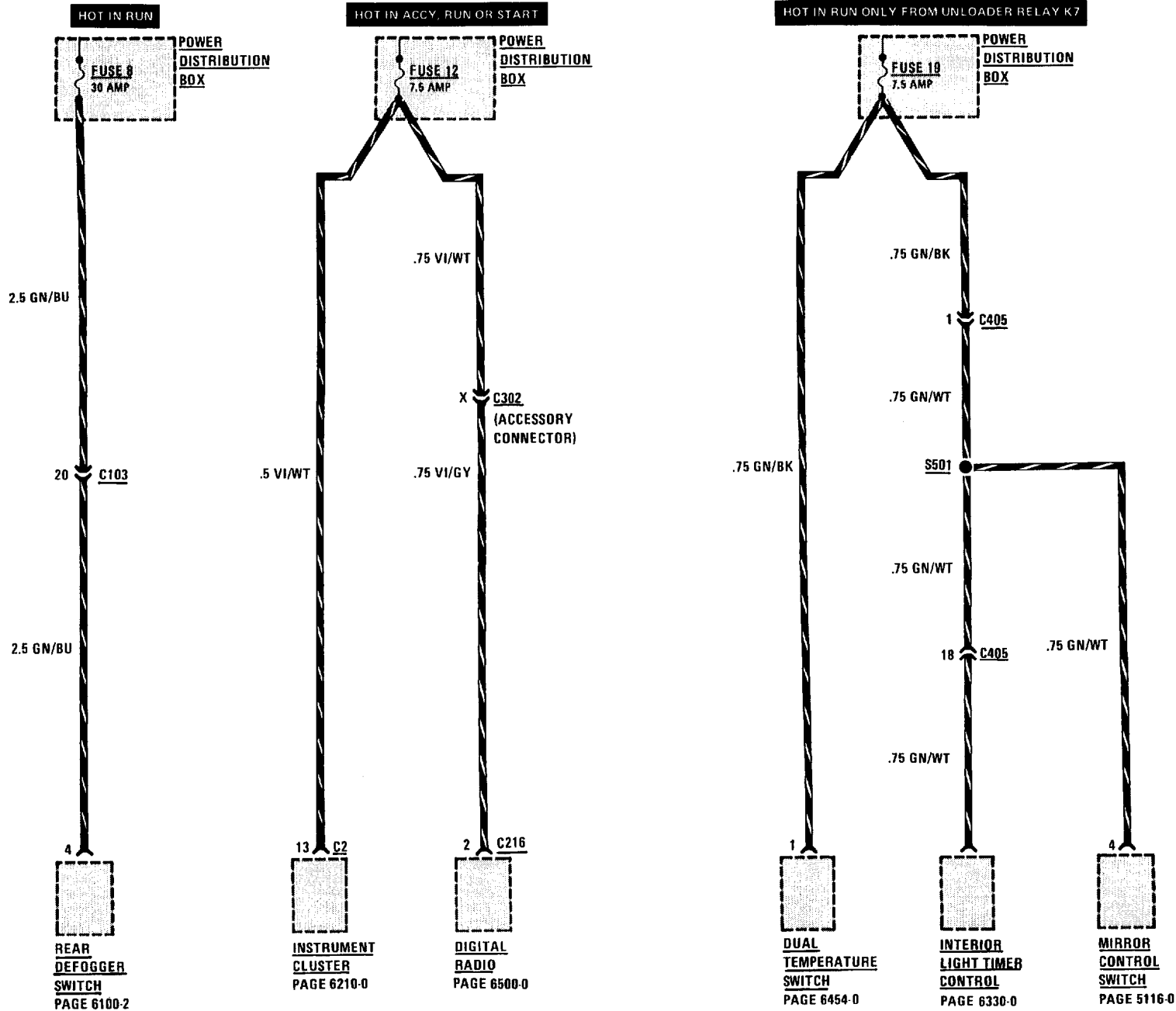

FUSE DETAILS: FUSE 10

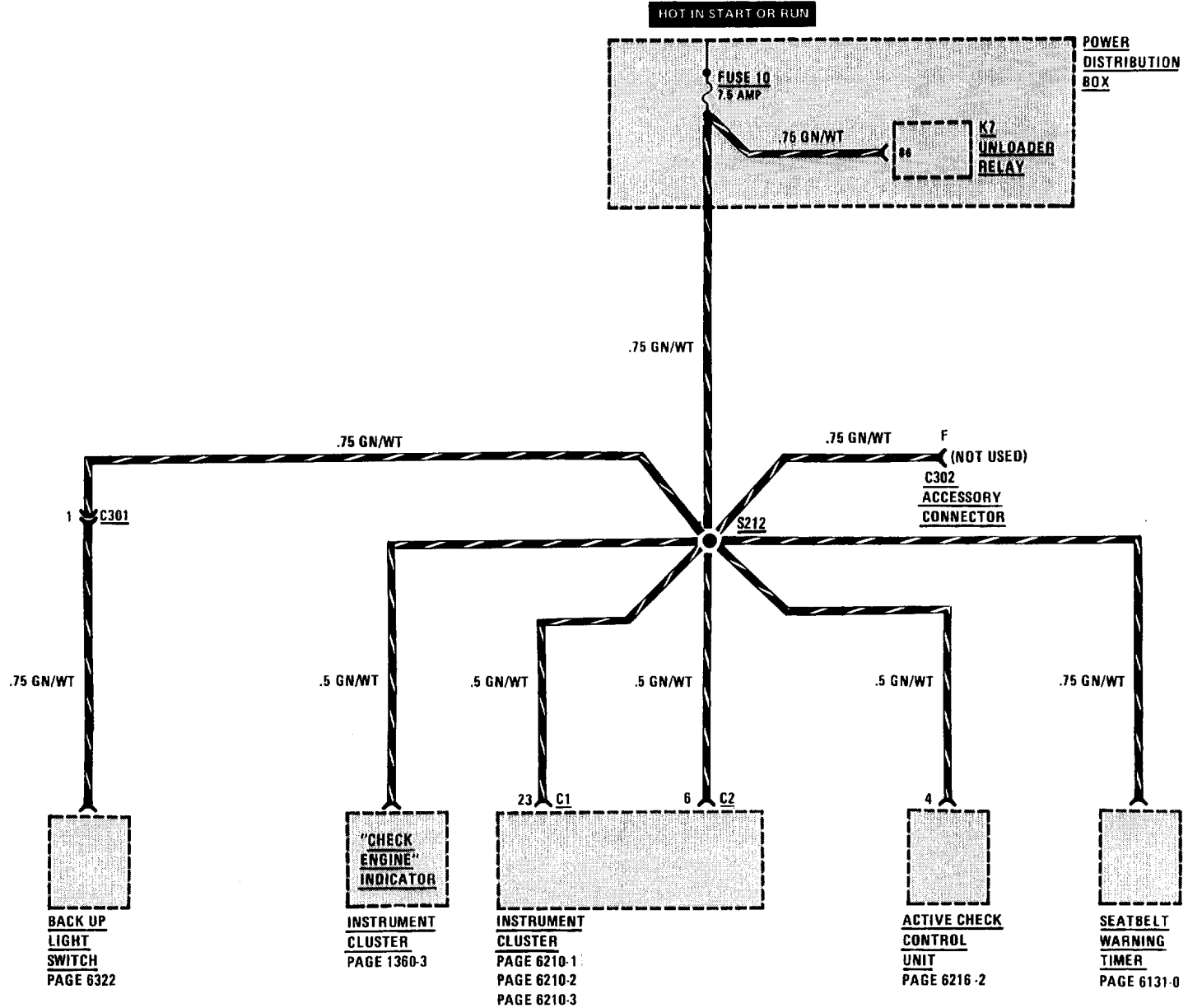

FUSE DETAILS: FUSE 20

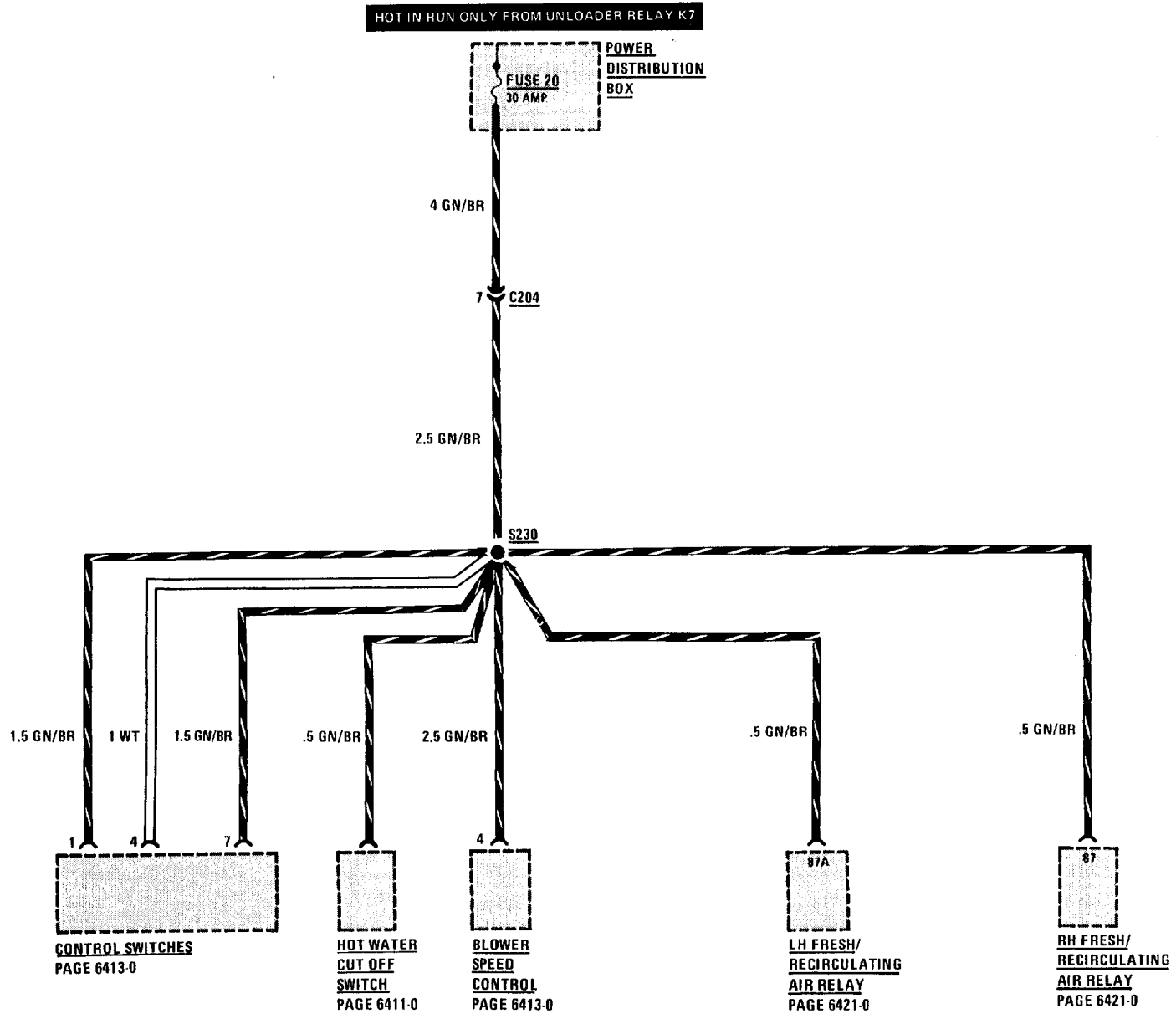

FUSE DETAILS: FUSES 27 AND 9

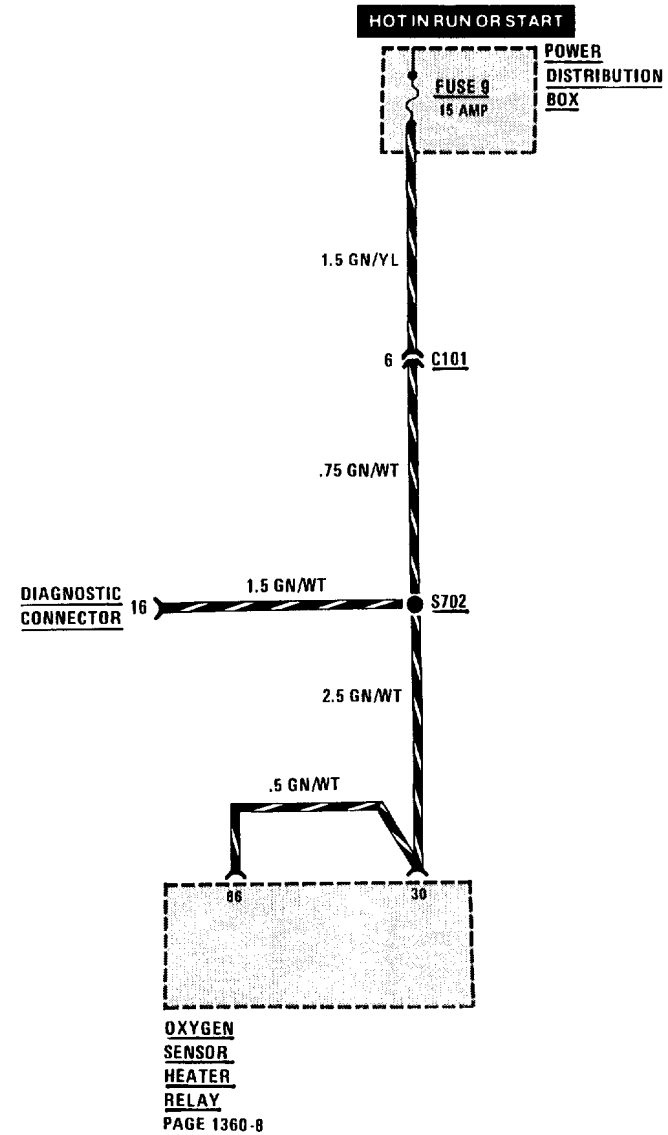
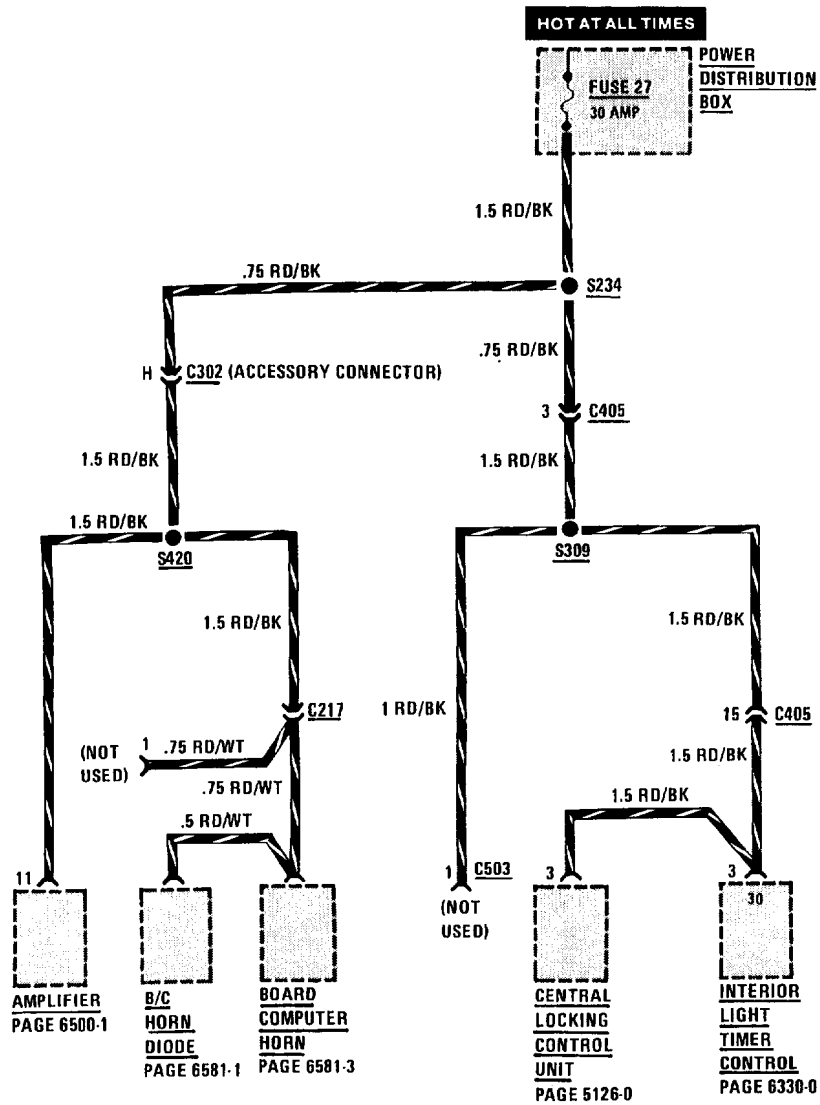

GROUND DISTRIBUTION: G200 (PARTIAL)

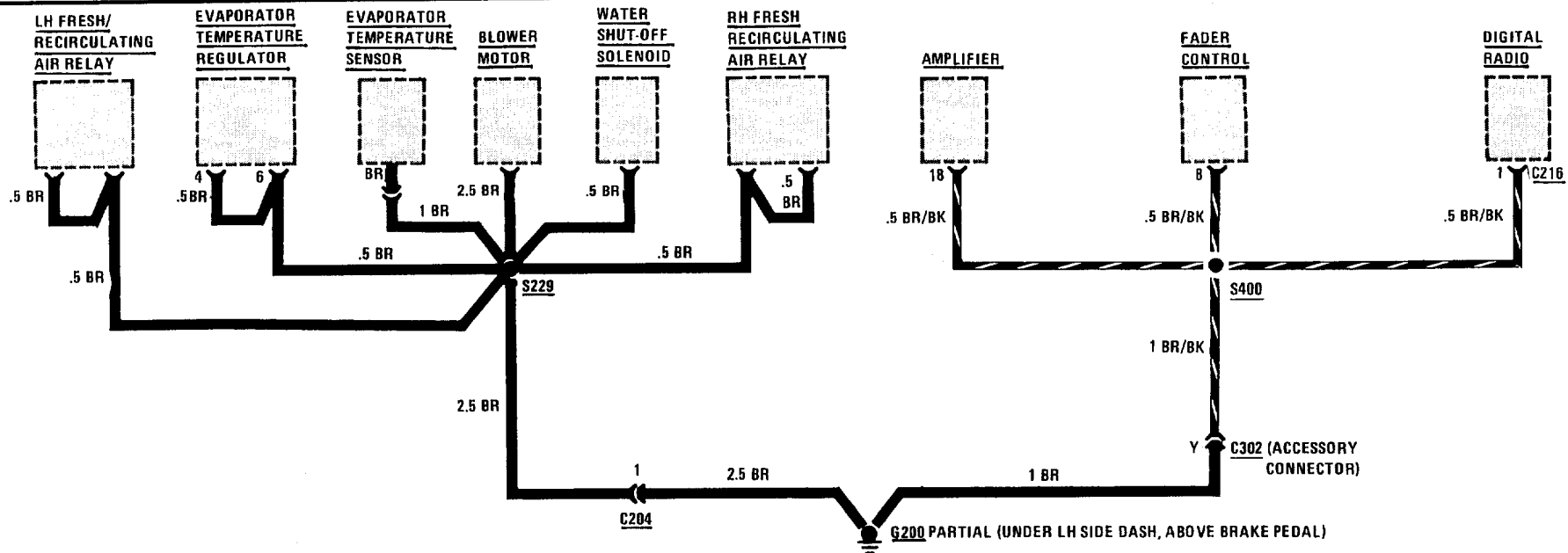
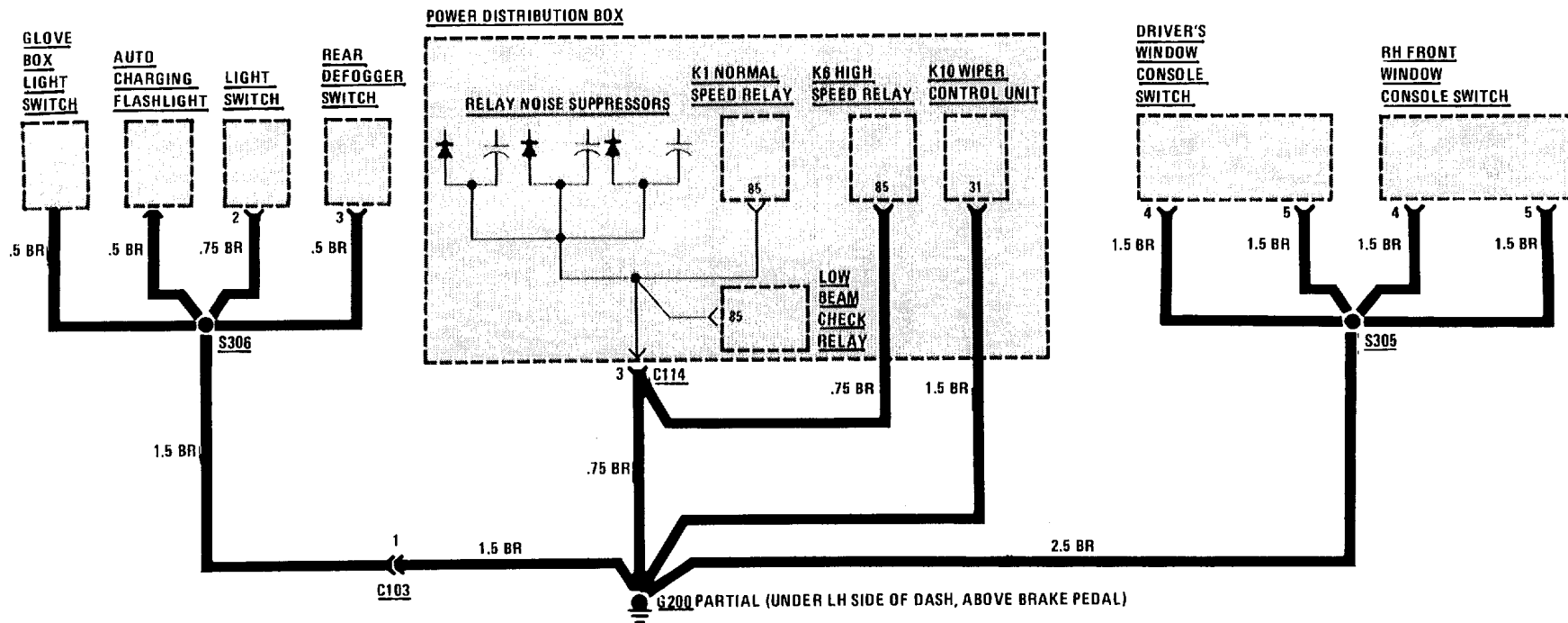

GROUND DISTRIBUTION: G200 (PARTIAL) AND G201

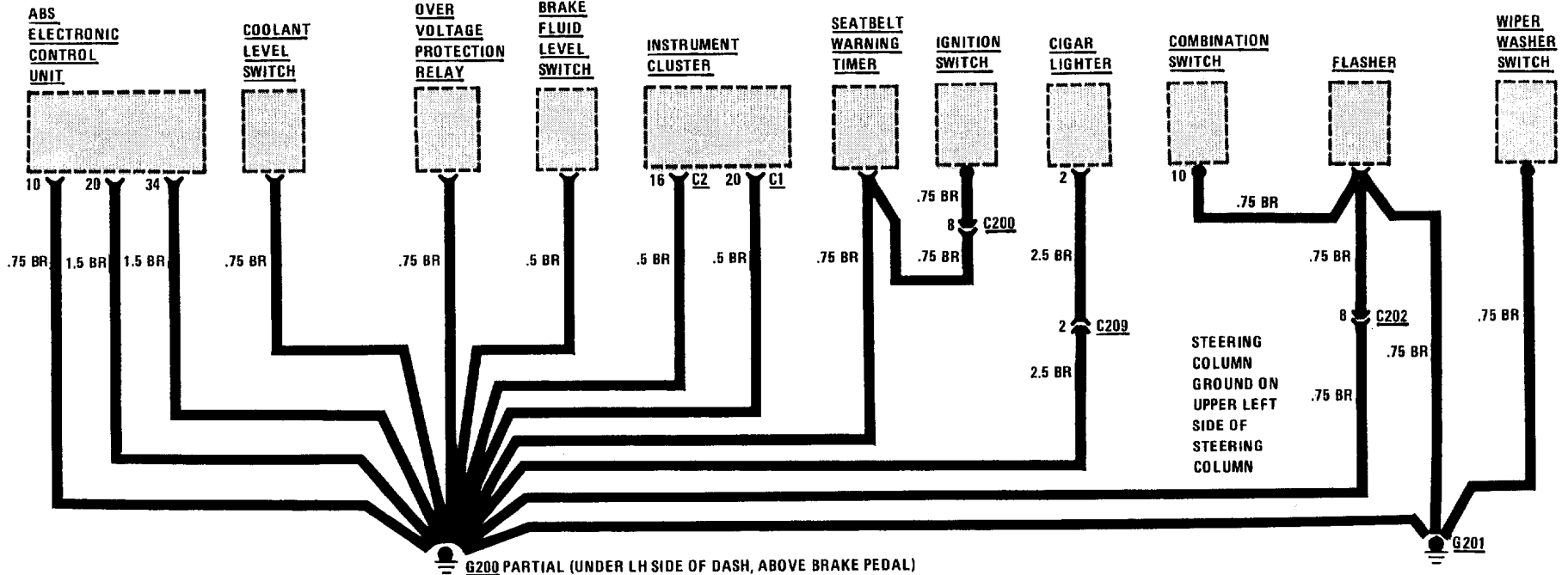
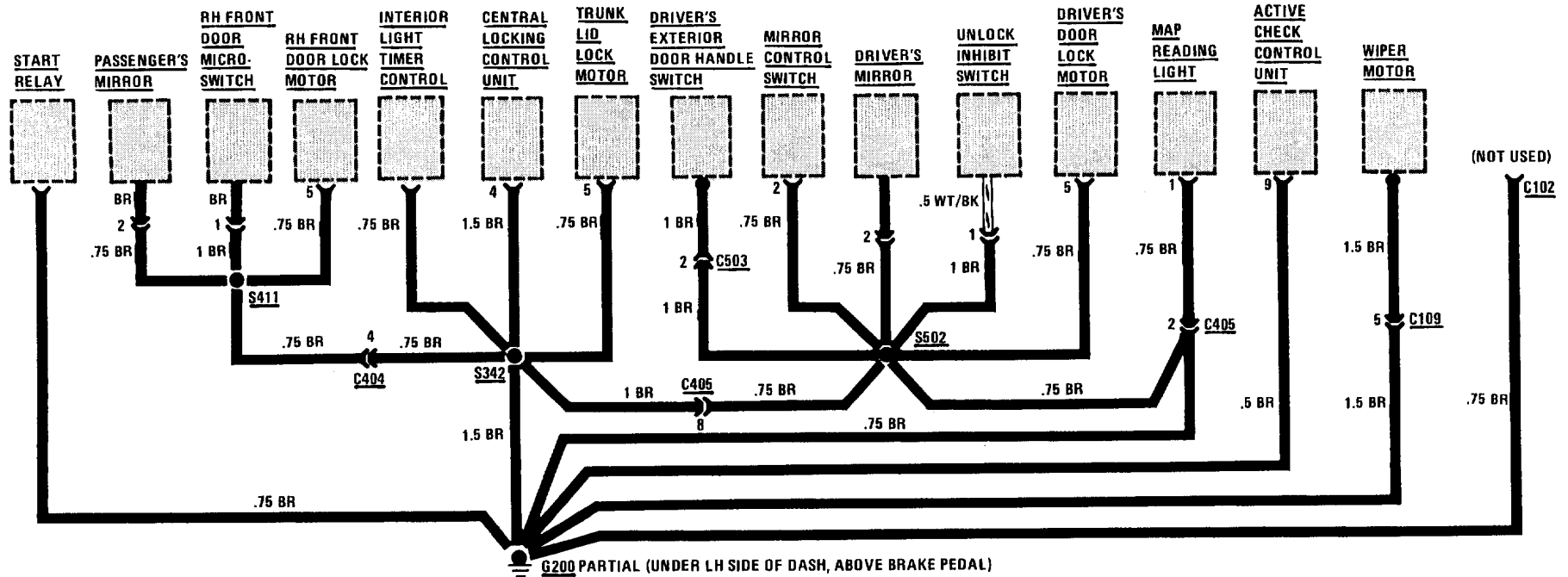

GROUND DISTRIBUTION: G200 (PARTIAL)

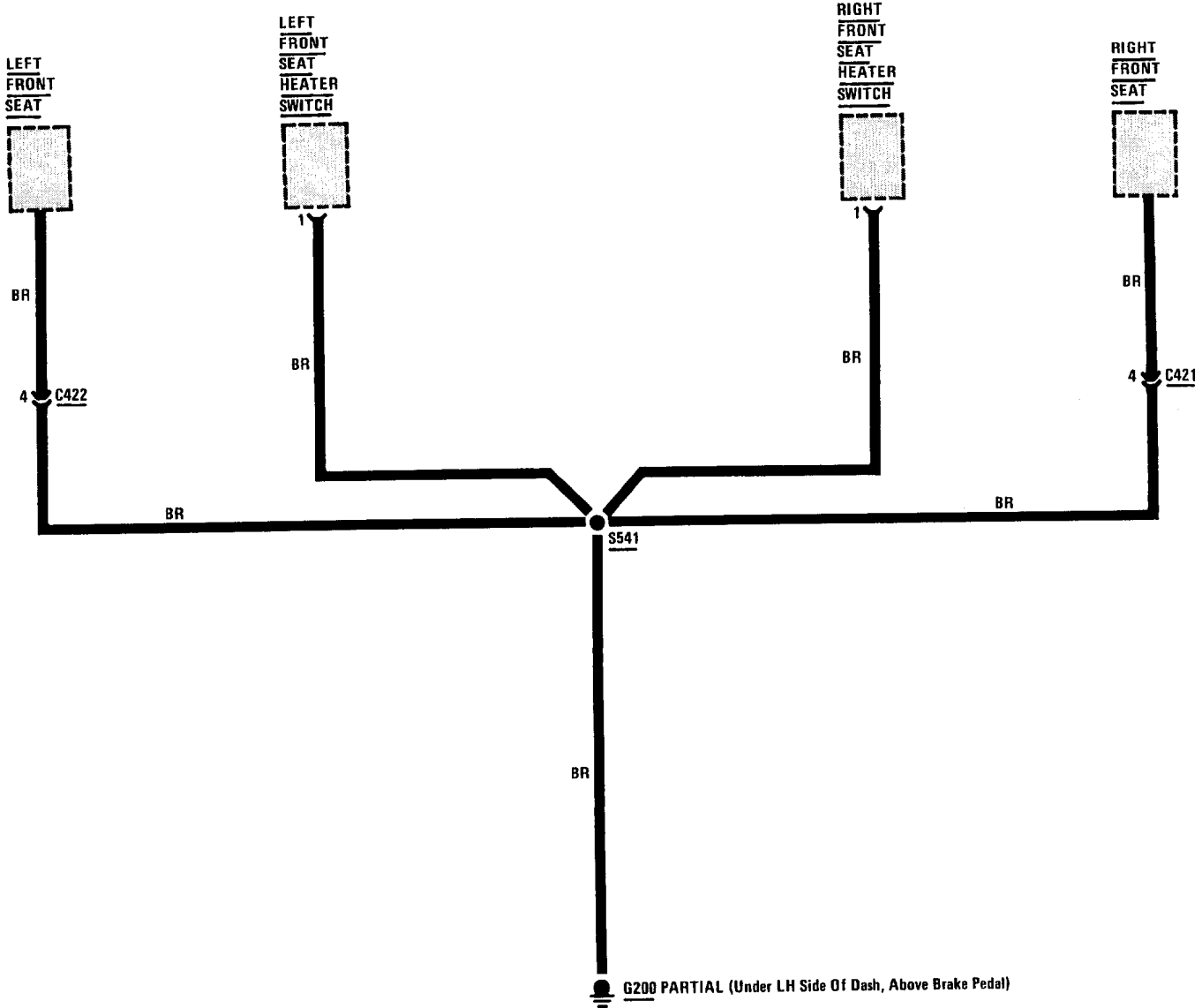

GROUND DISTRIBUTION: G300

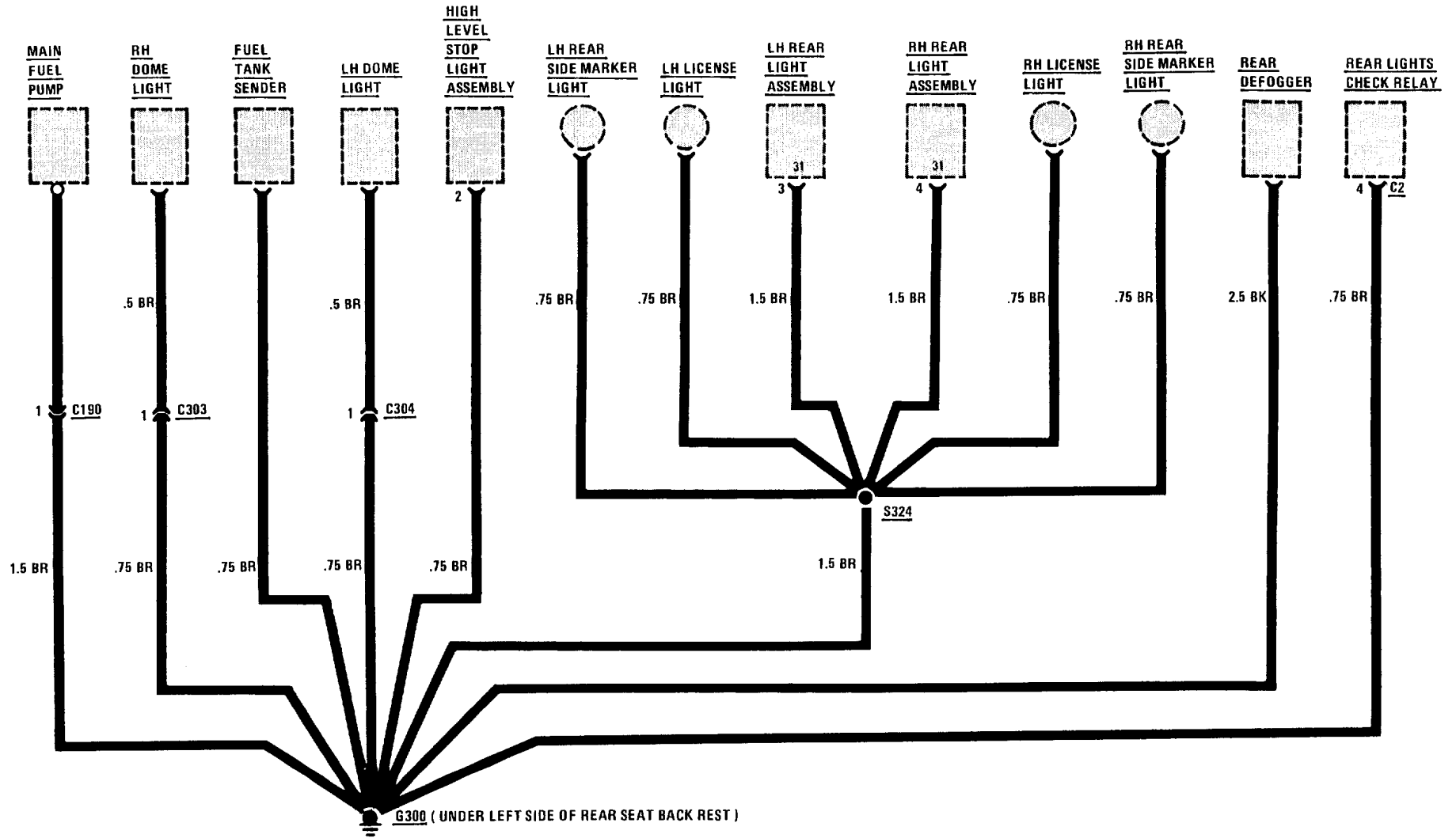

1230-0 CHARGE

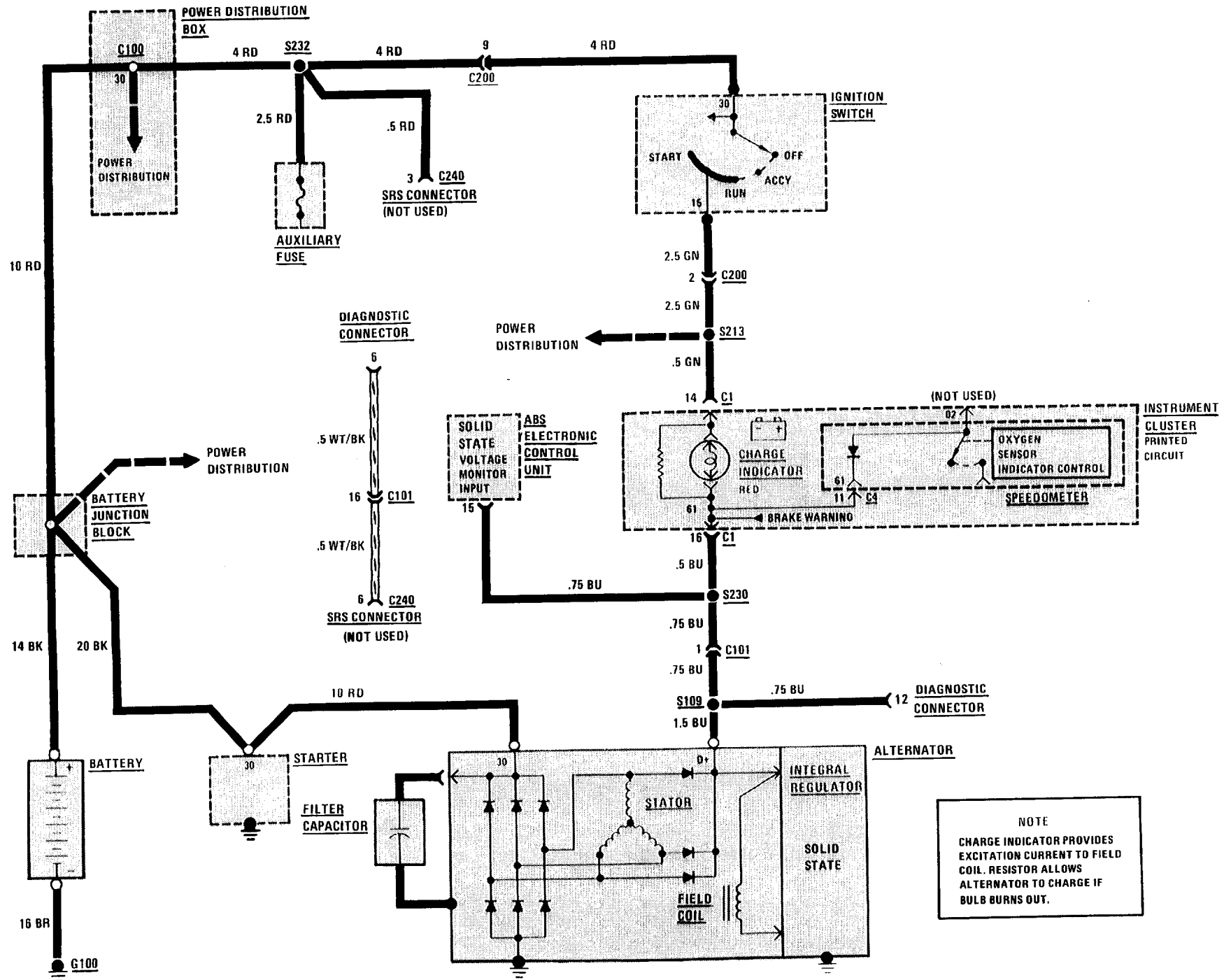

1360-0 INJECTION ELECTRONICS

ENGINE BLOCK DIAGRAM

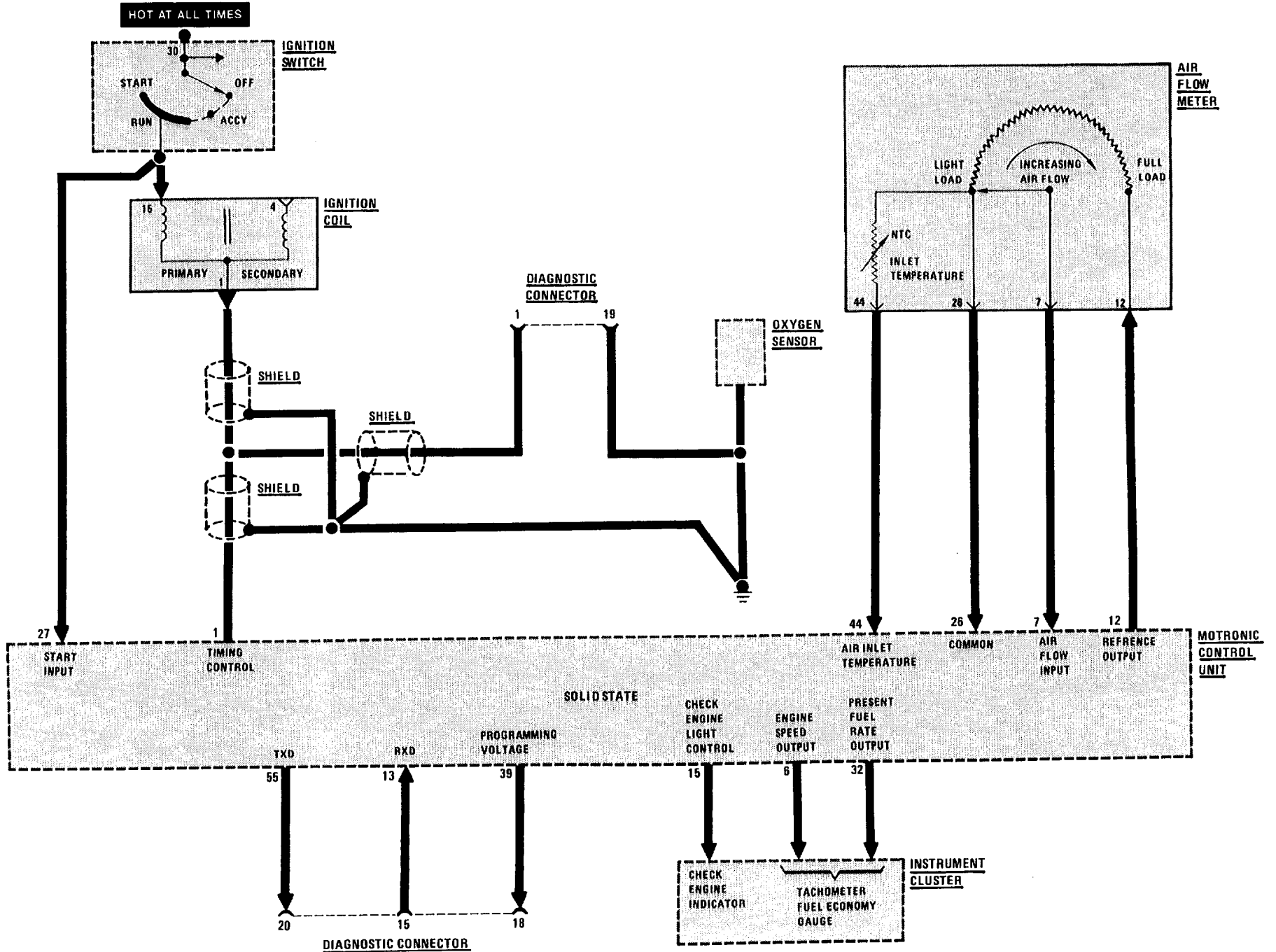

ENGINE BLOCK DIAGRAM

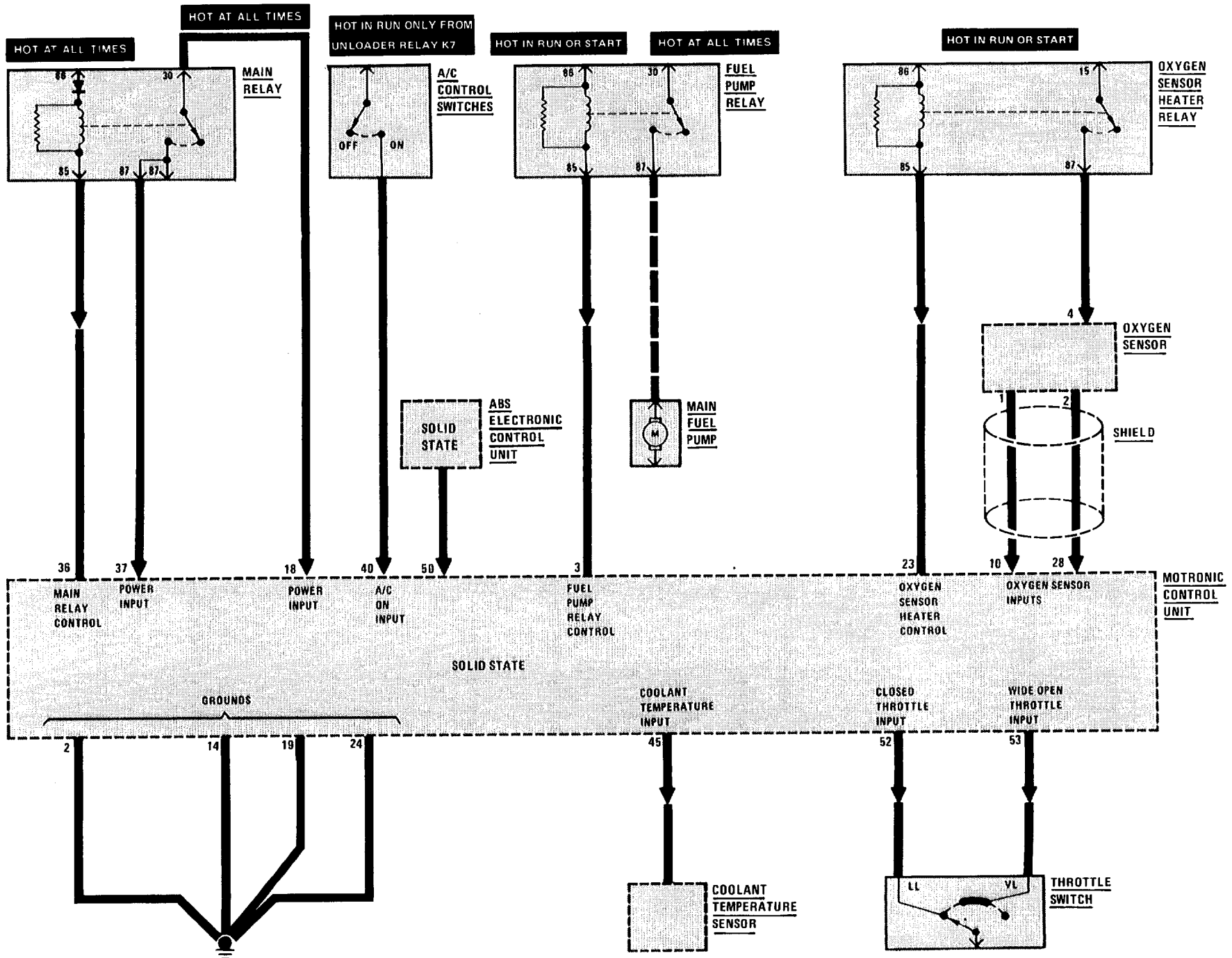

ENGINE BLOCK DIAGRAM

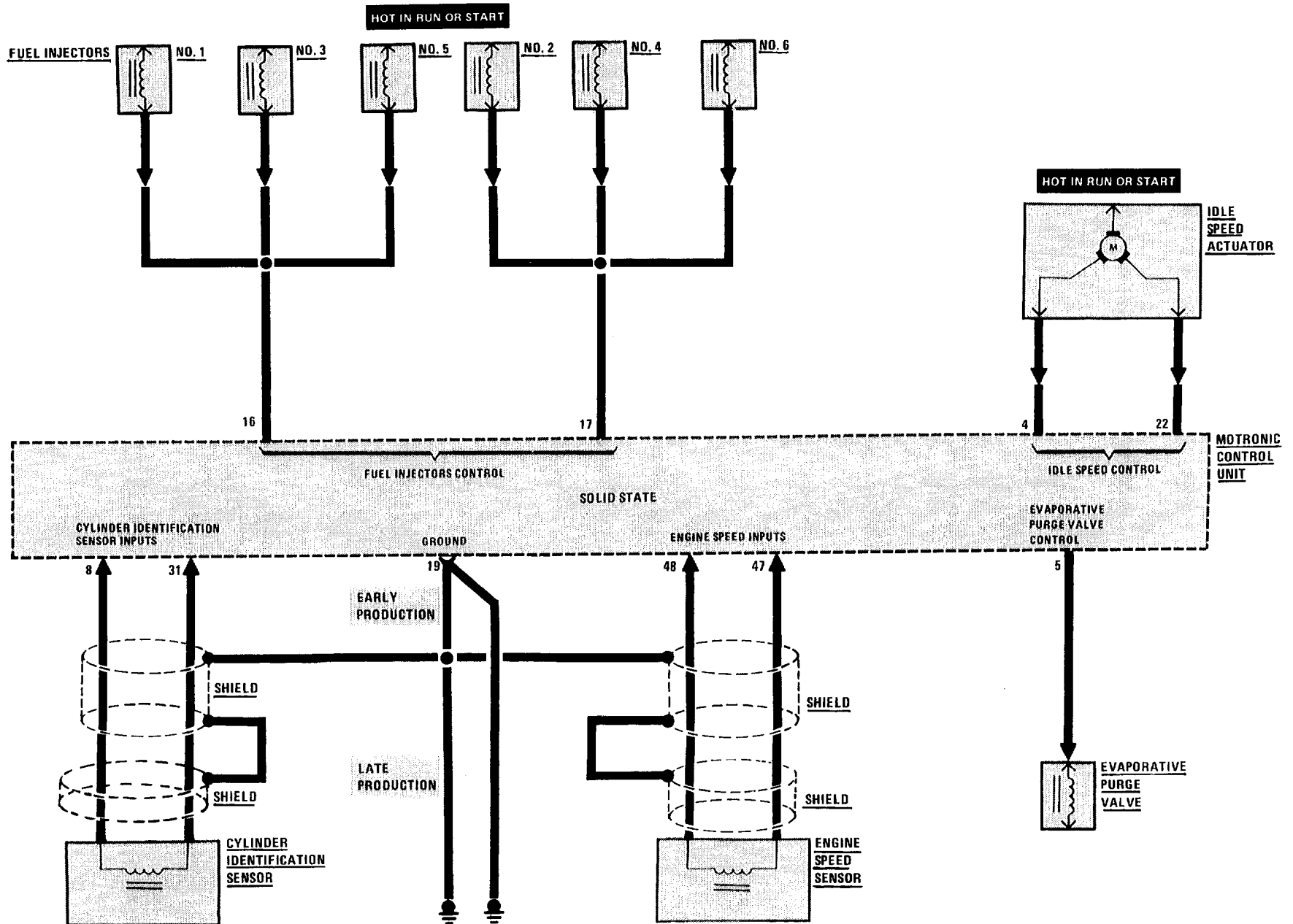

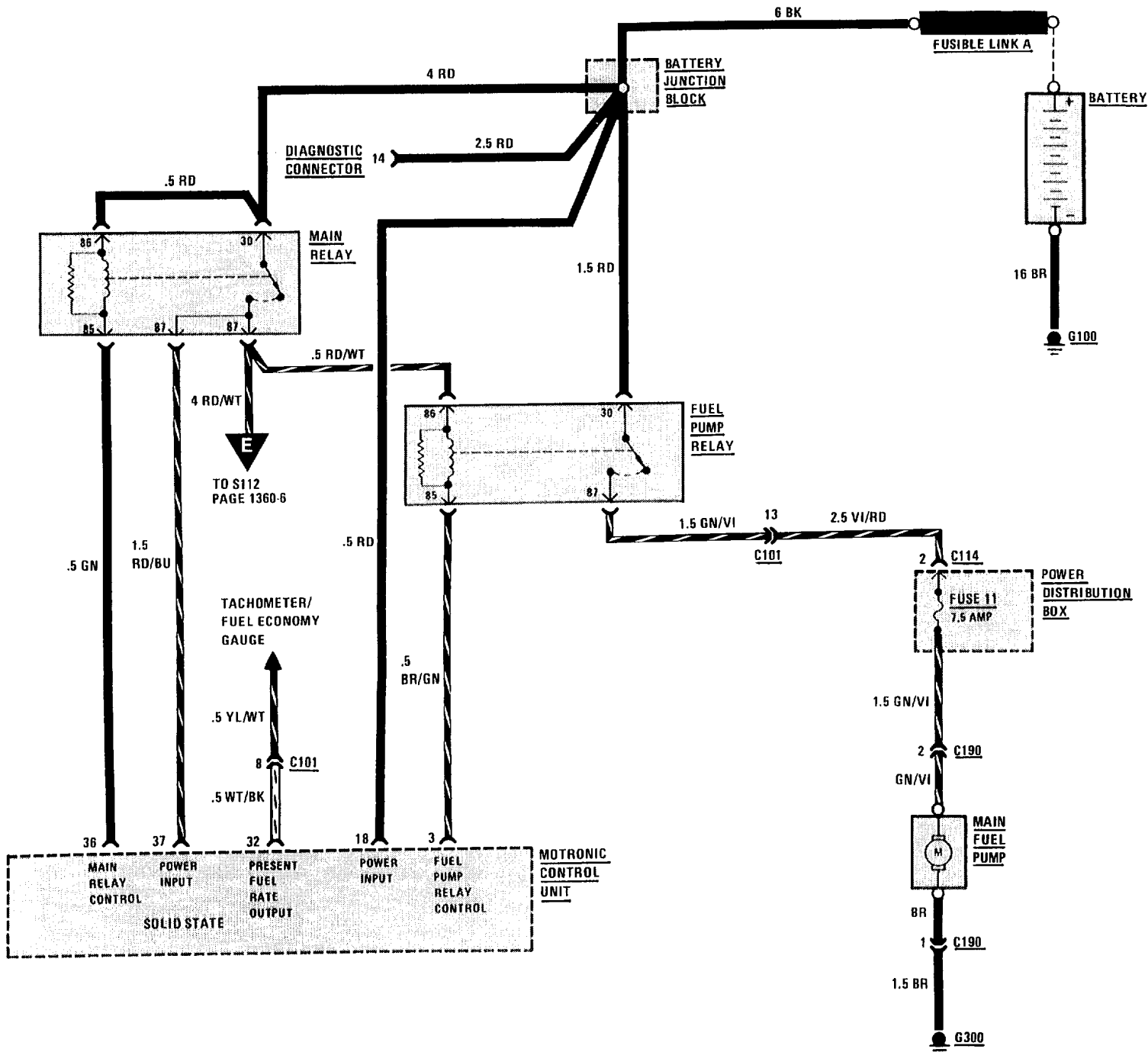

1360-4 INJECTION ELECTRONICS

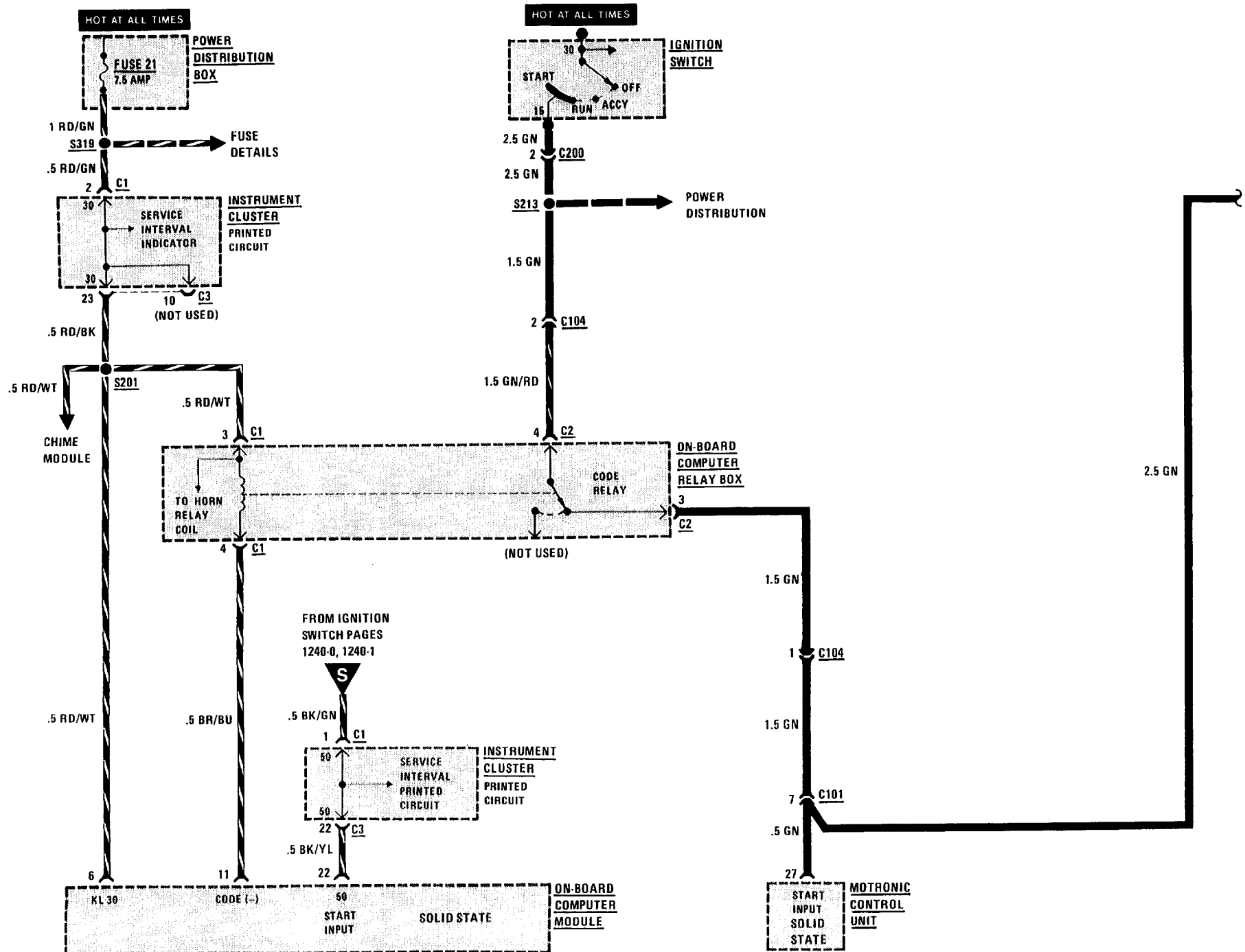

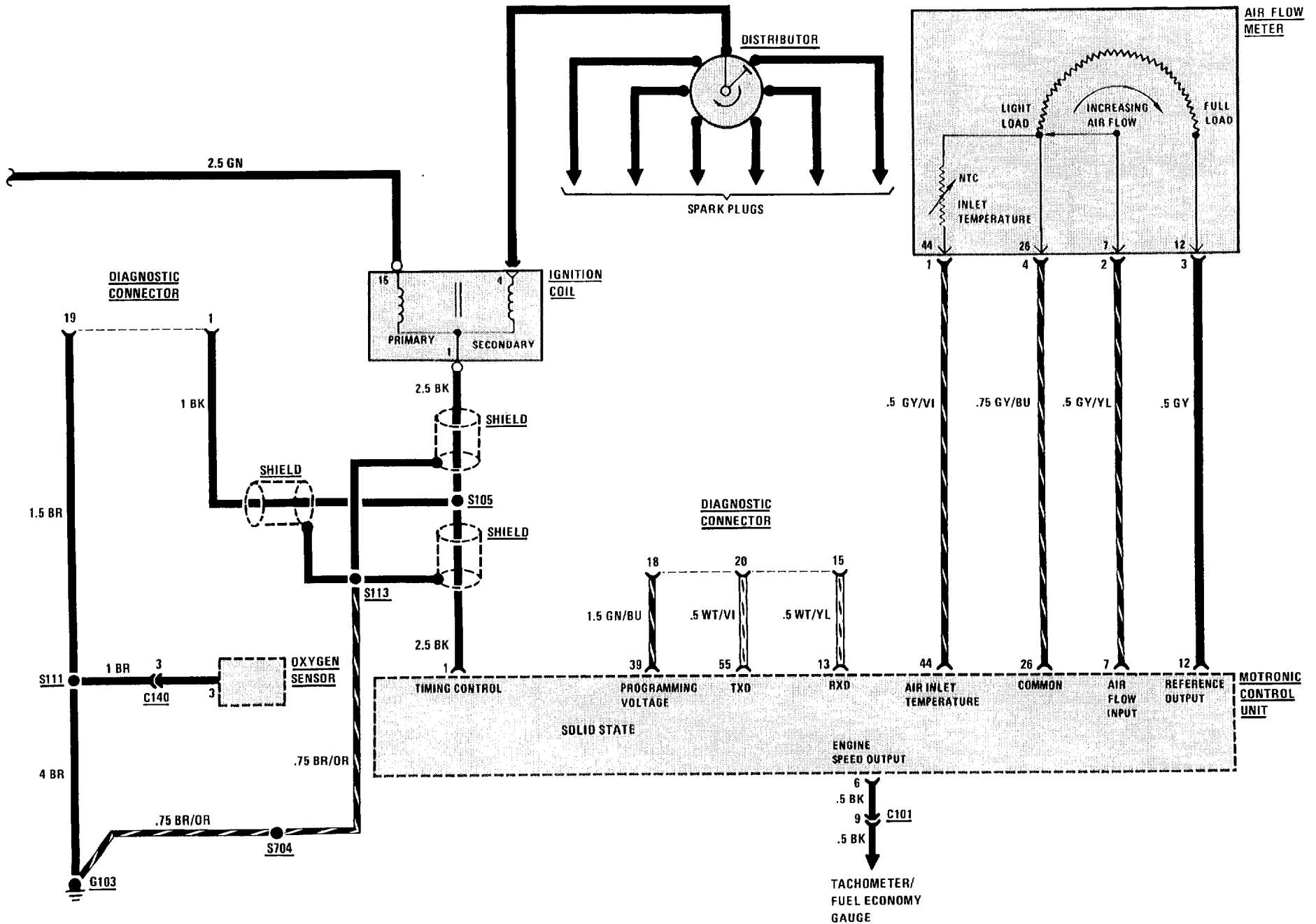

3435-0 BRAKE WARNING SYSTEM

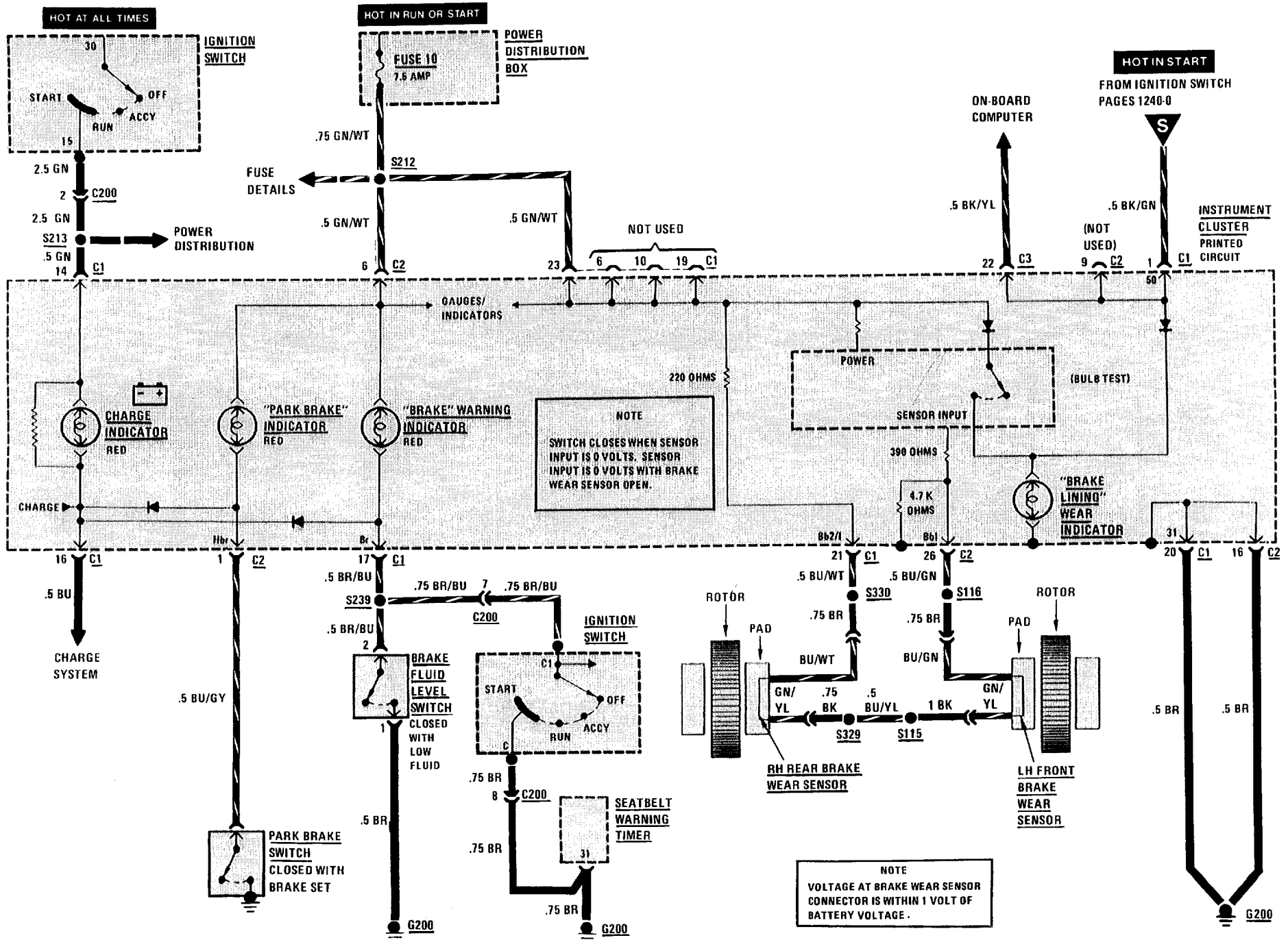

ANTILOCK BRAKING SYSTEM (ABS) 3450-1

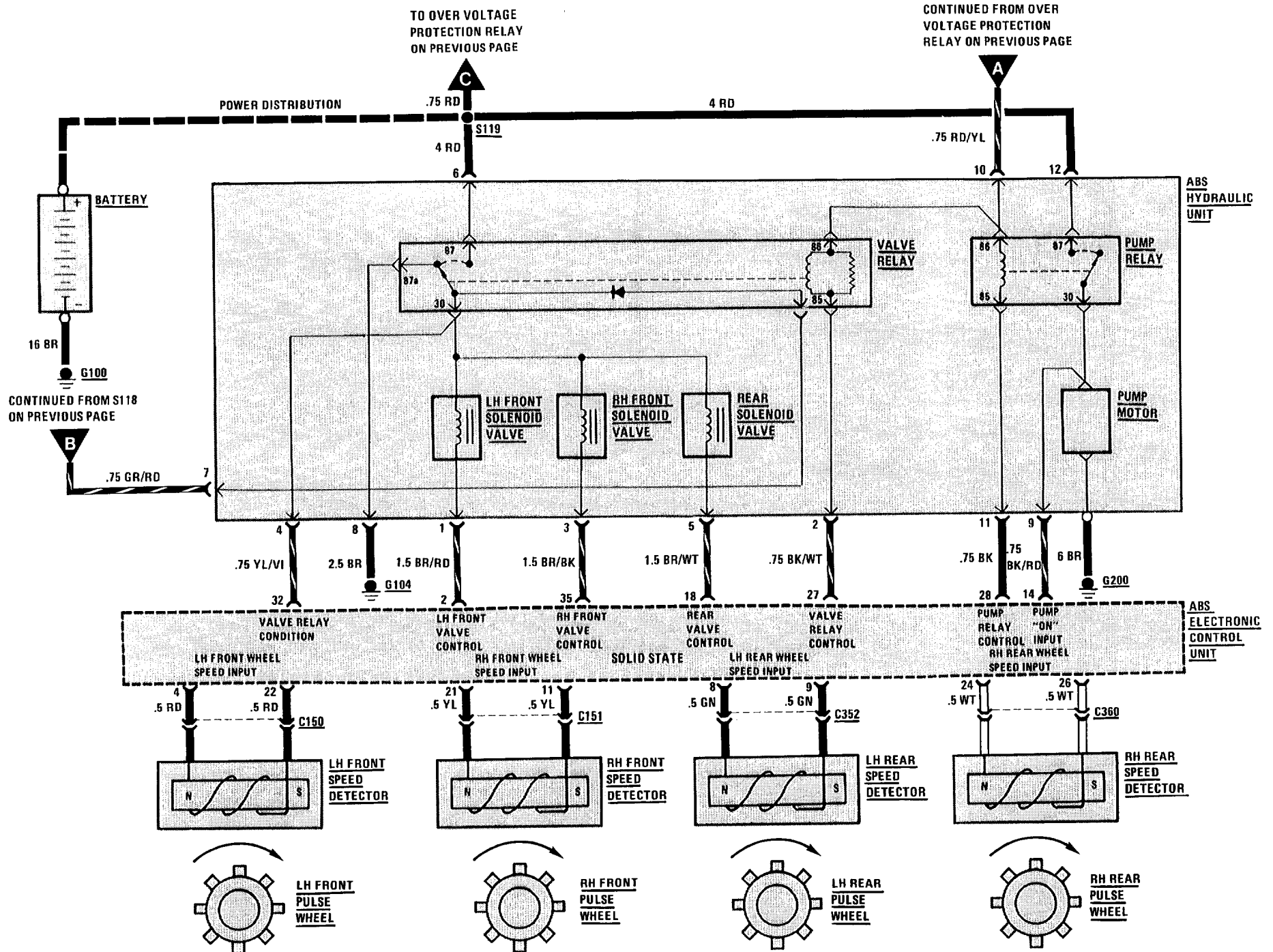

3450-2 ANTILOCK BRAKING SYSTEM (ABS)

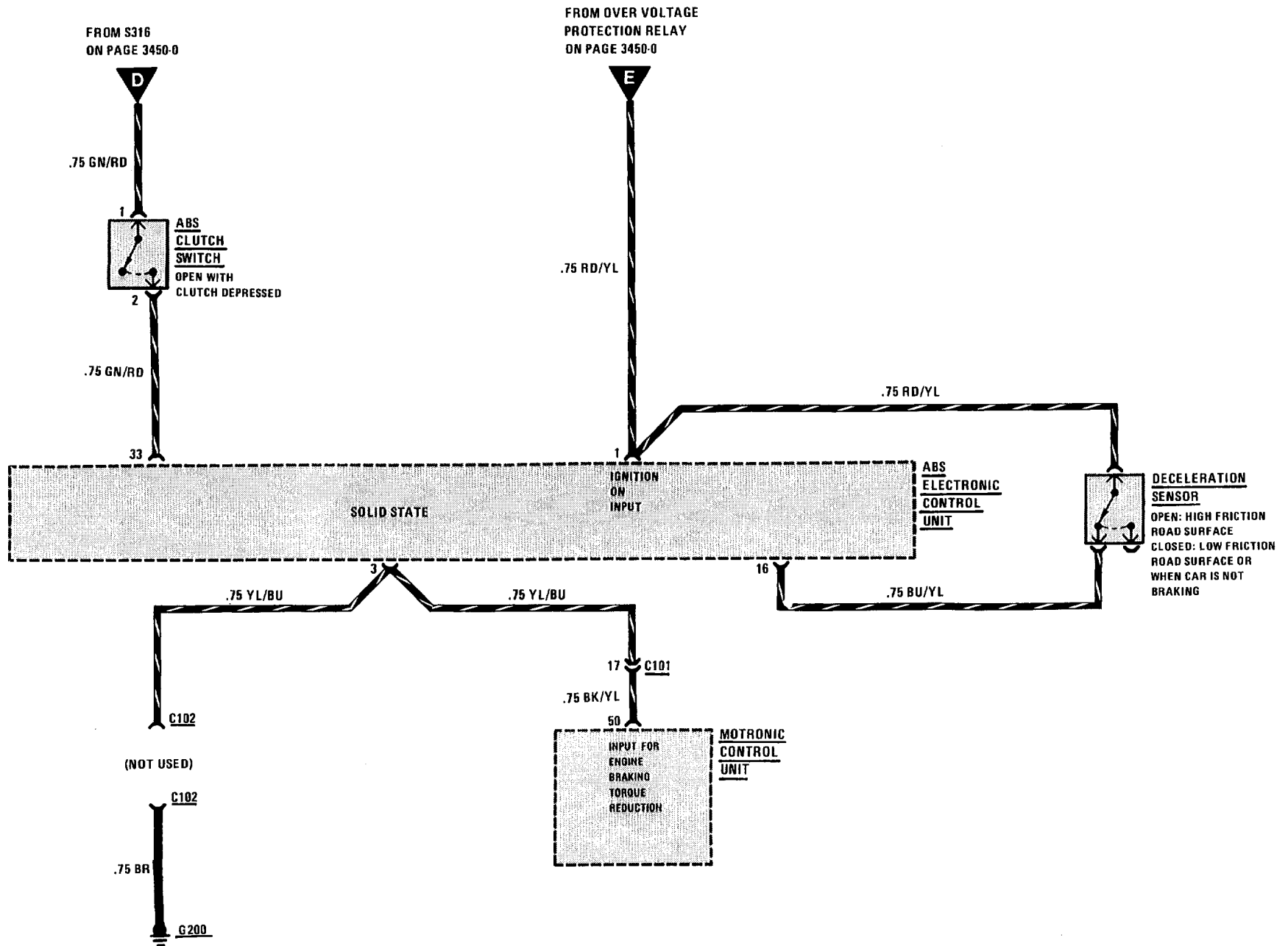

5116-0 POWER MIRRORS

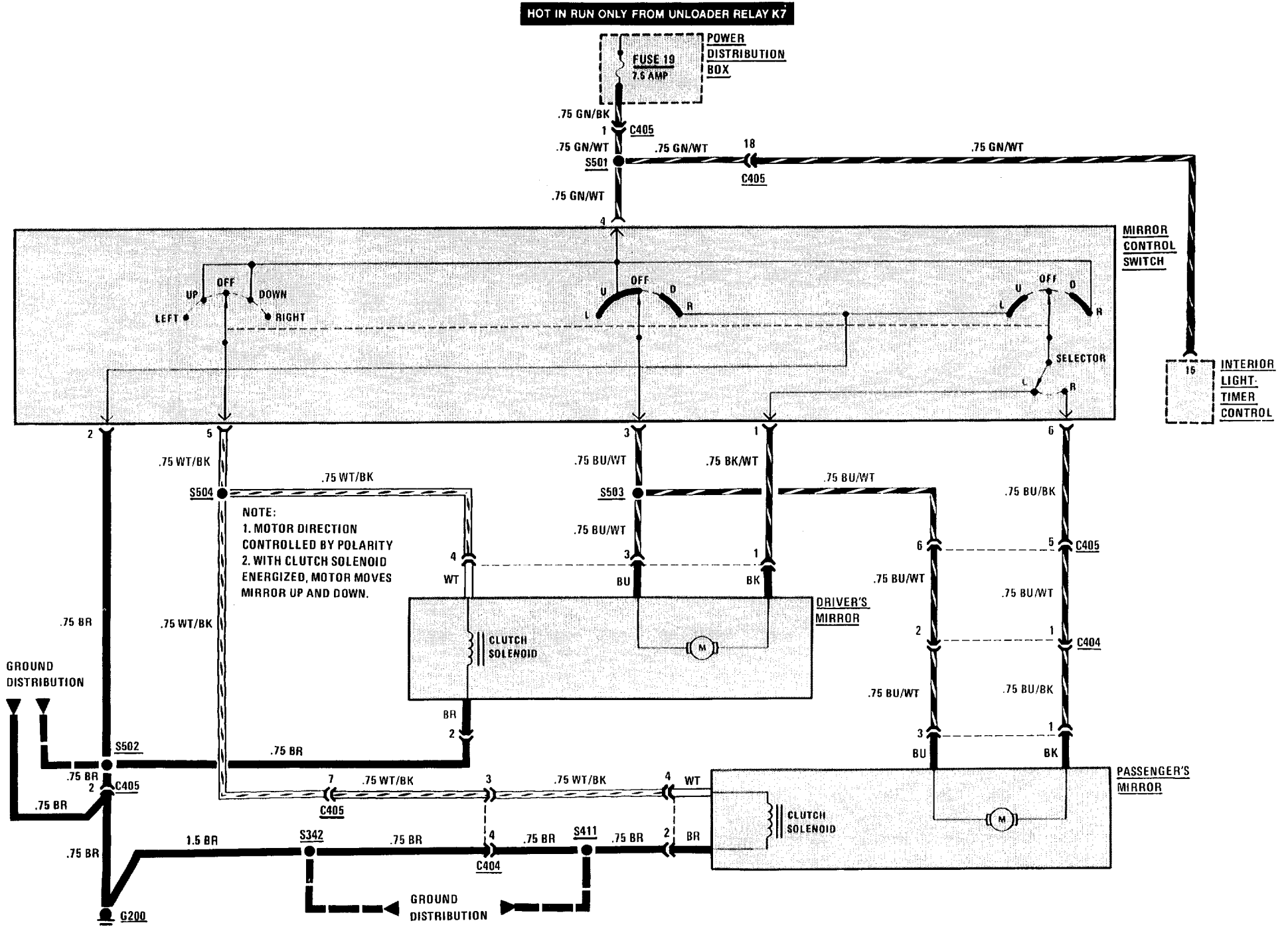

5126-0 CENTRAL LOCKING

2 DOOR (SELECT)

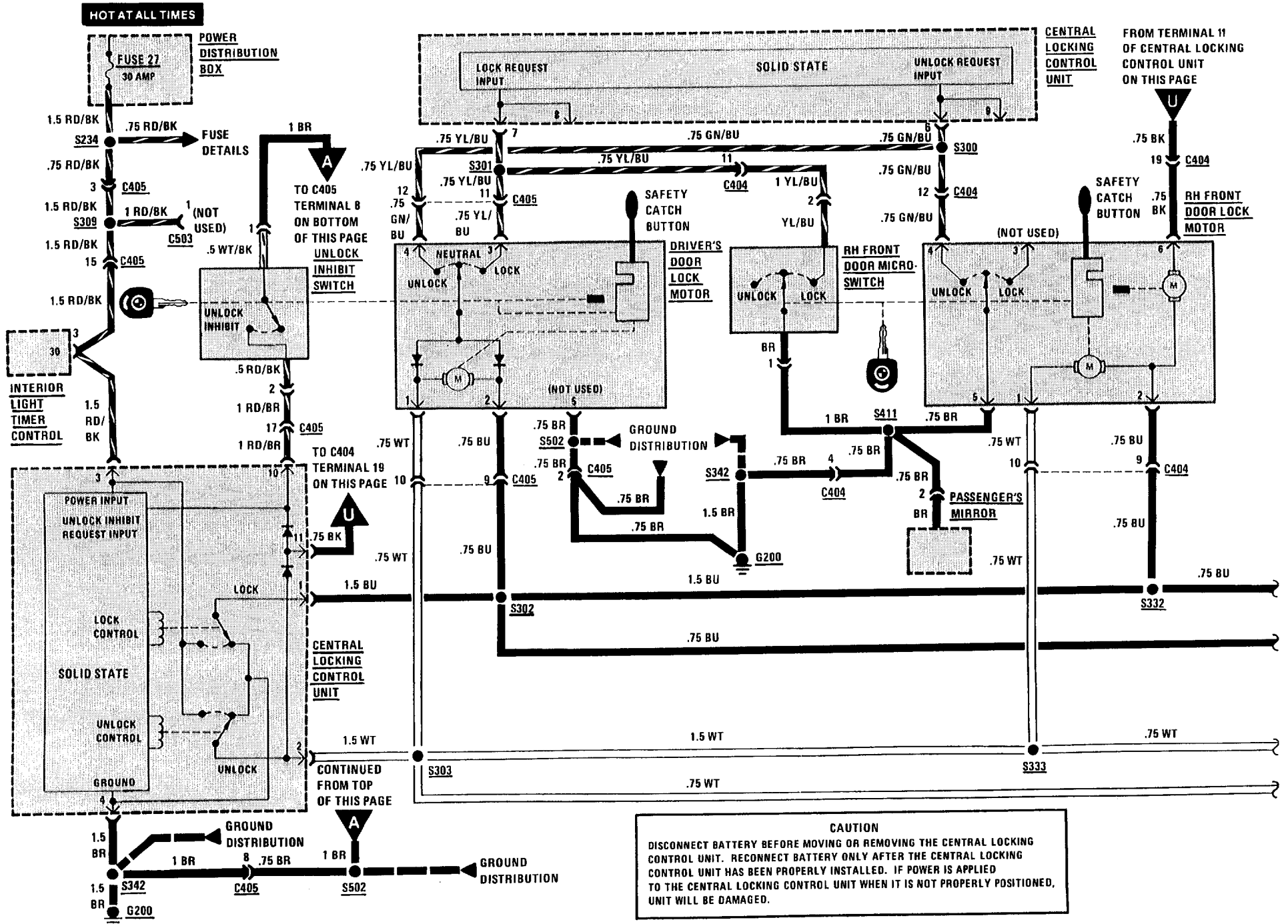

2 DOOR (CONTROL)

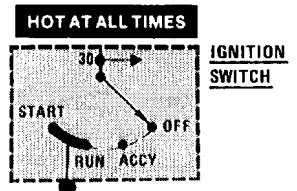

CAUTION
 DO NOT OPERATE THE SYSTEM MORE THAN 8 TIMES IN QUICK SUCCESSION TO PREVENT DAMAGE TO THE CENTRAL LOCKING CONTROL UNIT.

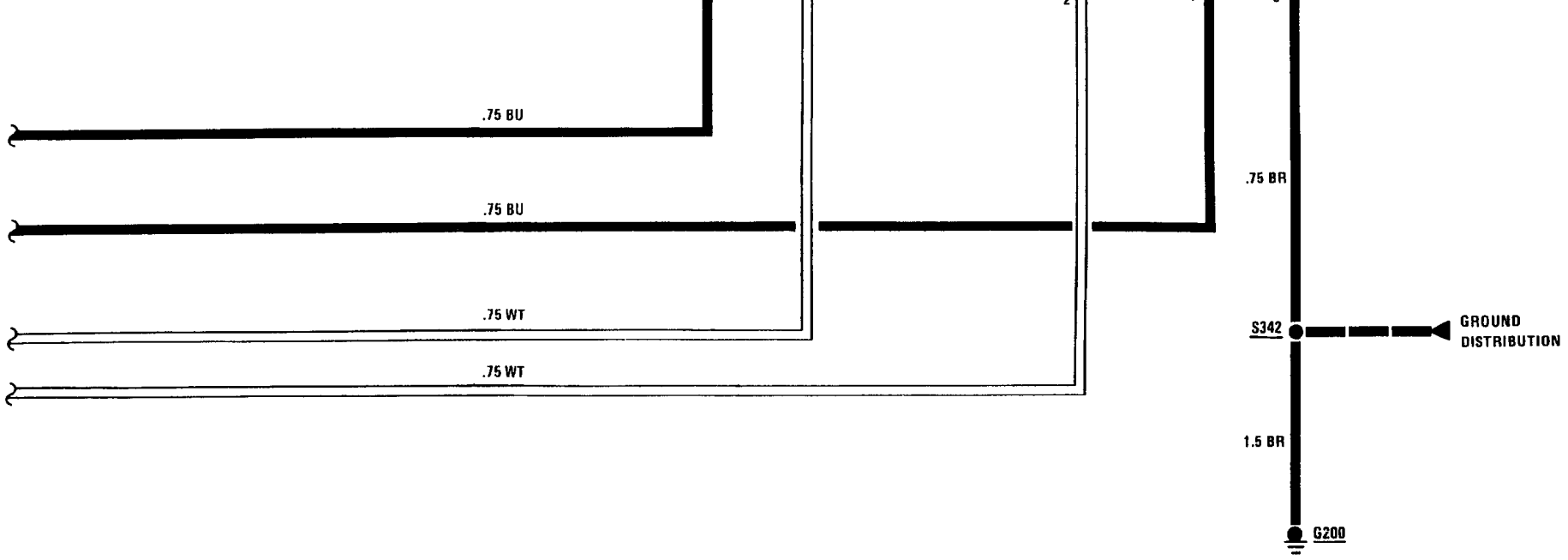
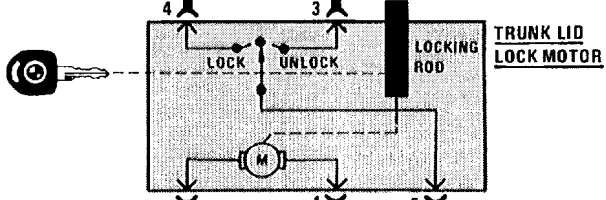
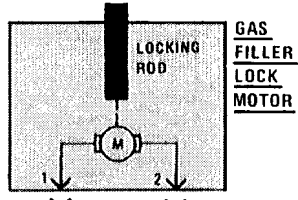
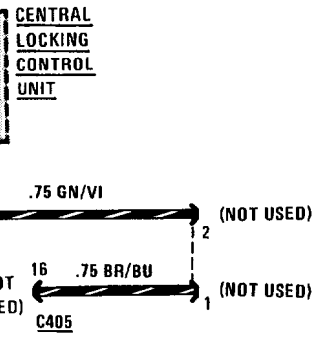
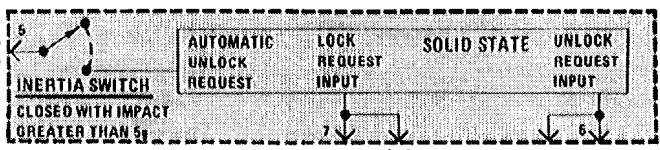
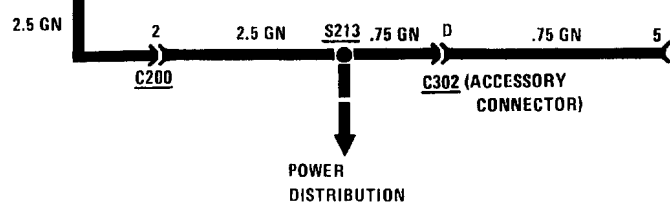

5126A-0 CENTRAL LOCKING

TROUBLESHOOTING HINTS

1. Check Fuse by operating the Interior Light Timer for either Dome Light.
2. If all locks stay in unlock inhibit, check the wires to terminal 10 of the Central Locking Control Unit for a short to ground.

SYSTEM CHECK

- Operate controls in sequence listed in the System Check Table.
- Refer to Repair Action for the Response received (tests follow the System Check Table).
- After any repair, repeat System Check to verify proper system operation.

NOTE: Before replacing any system component, check all connectors, splices, and wiring to that component.

SYSTEM CHECK TABLE

OPERATION	RESPONSE	REPAIR ACTION
1. Insert the key in the Driver's door and turn to LOCK	All doors lock	None, proceed to Operation 2
	Some doors lock	Repair/replace the suspect Door Lock Motor circuit
	No doors lock	Proceed to Operation 4
2. Turn the key to UNLOCK INHIBIT (clockwise until key is horizontal)	All doors double lock (Safety Catch Buttons cannot be pulled up by hand)	None, proceed to Operation 3
	Driver's door double locks and only some of the other doors double lock	Repair/replace the suspect Door Lock Motor
	Driver's door double locks but all the other doors do not double lock	Perform Test B
	Driver's door does not double lock	Mechanical problem, see BMW Troubleshooting Manual

SYSTEM CHECK TABLE (CONT'D)

OPERATION	RESPONSE	REPAIR ACTION
3. Turn the key to UNLOCK	All doors unlock	None, proceed to Operation 4
	Some doors unlock	Repair/replace the suspect Door Lock Motor circuit
	No doors unlock	Proceed to Operation 5
4. Insert the key in the Passenger's door and turn to LOCK	All doors lock	If the doors did not lock in Operation 1, repair/replace the Driver's Door Lock Switch, otherwise proceed to Operation 5
	Some doors lock	Repair/replace the suspect Door Lock Motor circuit
	No doors lock	If all the doors locked in Operation 1, repair/replace the Right Front Door Microswitch. If the doors did not lock in Operation 1, perform Test A
5. Insert the key in the Passenger's door and turn to UNLOCK	All doors unlock	If all the doors did not unlock in Operation 3, repair/replace the Driver's Door Lock Switch, otherwise proceed to Operation 6
	Some doors unlock	Repair/replace the suspect Door Lock Motor
	No doors unlock	If all the doors unlocked in Operation 3, repair/replace the Passenger's Door Lock Switch. If the doors did not unlock in Operation 3, perform Test C
6. Get in the car and close and lock all doors Turn the Ignition Switch to RUN	Doors remain locked	None, proceed to Operation 7
	Doors unlock	Repair/replace the Central Locking Control Unit
7. Get out of the car Insert the key in the Driver's door and turn to LOCK Unlock each of the doors by pulling up the Safety Catch Buttons	All doors can be unlocked	None, proceed to Operation 8
	All doors remain secure	Disconnect the connector from the Central Locking Control Unit and check for a short to ground in the wires at terminal 11. • If short to ground is not present, replace the Central Locking Control Unit. • If short to ground is present isolate wiring from Door Lock Motors one at a time to find short

5126A-2 CENTRAL LOCKING

SYSTEM CHECK TABLE (CONT'D)

OPERATION	RESPONSE	REPAIR ACTION
8. Insert the key in the Trunk Cylinder Switch. Turn the key to LOCK	Trunk locks	None, proceed to Operation 9
	Trunk does not lock	If the doors lock, repair/replace the Trunk Lock Motor Circuit or Trunk Lock Motor If the doors do not lock, repair/replace the Trunk Switch Repair/replace the Central Locking Control Unit if the Trunk Switch Circuit is OK
9. Turn the key to UNLOCK	Trunk unlocks	None, proceed to Operation 10
	Trunk does not unlock	If the doors unlock, repair/replace the Trunk Lock Motor circuit or Trunk Lock Motor If the doors do not unlock, repair/replace the Trunk Switch Repair/replace the Central Locking Control Unit if the Trunk Switch Circuit is OK
10. Turn the key back to LOCK	Gas Filler locks	None, proceed to Operation 11
	Gas Filler does not lock	Repair/replace the Gas Filler Lock Motor circuit
11. Turn the key to UNLOCK	Gas Filler unlocks	None
	Gas Filler does not unlock	Repair/replace the Gas Filler Lock Motor circuit

- If all results are normal, the system is OK.

SYSTEM DIAGNOSIS

- Do the following tests when directed by the System Check Table.

A: CONTROL UNIT LOCK TEST (TABLE 1)

Measure: VOLTAGE At: CONTROL UNIT CONNECTOR (Connected)		
Measure Between	Correct Voltage	For Diagnosis
3 & Ground	Battery	See 1
3 & 4	Battery	See 2
<ul style="list-style-type: none"> • If the voltages are correct, proceed to Table 2. 1. Check the wire to terminal 3 for an open. 2. Check the wire from terminal 4 for an open to ground (see schematic). 		

A: CONTROL UNIT LOCK TEST (TABLE 2)

Connect: A FUSED JUMPER At: CONTROL UNIT CONNECTOR (Connected)		
Jumper Between	Correct Result	For Diagnosis
7 & Ground	Doors lock	See 1
<ul style="list-style-type: none"> • If the result is correct, repair/replace the switches and related wiring (see schematic). 1. Proceed to Table 3. 		

**A: CONTROL UNIT LOCK TEST
(TABLE 3)**

Connect: FUSED JUMPERS At: CONTROL UNIT CONNECTOR (Disconnected)		
Jumper Between	Correct Result	For Diagnosis
1 & 3 2 & 4	Doors lock	See 1
<ul style="list-style-type: none"> If the result is correct, replace the Central Locking Control Unit. <ol style="list-style-type: none"> Check the wire from terminal 1 to splice and the wire from terminal 3 to splice for opens (see schematic). 		

B: UNLOCK INHIBIT TEST

Connect: A FUSED JUMPER At: CONTROL UNIT CONNECTOR (Connected)		
Jumper Between	Correct Result	For Diagnosis
10 & Ground	Doors double lock	See 1
<ul style="list-style-type: none"> If the result is correct, check the wires from terminal 10 to ground for opens (see schematic). Replace the Unlock Inhibit Switch if the wires and connections are OK. <ol style="list-style-type: none"> Check the wires from terminal 11 for opens (see schematic). Replace the Central Locking Control Unit, if the wires and connections are OK. 		

C: CONTROL UNIT UNLOCK TEST

Connect: A FUSED JUMPER At: CONTROL UNIT CONNECTOR (Connected)		
Jumper Between	Correct Result	For Diagnosis
6 & Ground	Doors unlock	See 1
<ul style="list-style-type: none"> If the result is correct, repair/replace the switches and related wiring (see schematic). <ol style="list-style-type: none"> Replace the Central Locking Control Unit. 		

CIRCUIT DESCRIPTION

The Central Locking System is controlled by the Central Locking Control Unit. This unit senses when a lock switch is moved by a key, and sends the appropriate signal to drive the Motors. The Central Locking Control Unit controls the Door Locks, Gas Filler Lock and Trunk Lock. The unit also has an Inertia Switch which closes on impact greater than 5g. If in RUN or START the locks are then unlocked.

Lock

When the Key is inserted into a lock and turned clockwise, the Lock switch moves to LOCK and grounds terminal 7 of the Central Locking Control Unit. The unit then activates the Lock Relay and applies voltage from Fuse 27 to the Lock Motor, which is grounded through the Central Locking Control Unit terminal 2. The Lock Motor then pulls the lock down. The door locks also control the Trunk Lock and Gas Filler Lock.

Unlock

When the key is turned counterclockwise, terminal 6 of the Central Locking Control Unit is grounded through the Lock Switch. The Central Locking Control Unit then activates the Unlock Relay and applies voltage from Fuse 27, through terminal 2 to the Lock Motor. The motor is grounded through the Central Locking Control Unit terminal 1. The polarity is reversed and the motor pushes the lock up.

Unlock Inhibit

When the key is inserted into the Driver's Lock and turned clockwise past the LOCK position, the Unlock Inhibit mechanism is engaged. This mechanically inserts a bar into the driver's lock and prevents unlocking through use of the Safety Catch Button. When in the Unlock Inhibit position, ground is applied to the Unlock Inhibit motors in the other lock units. The Central Locking Control Unit is grounded at terminal 10 and then activates the Lock Relay. Voltage is applied to the Unlock Inhibit motors through terminal 1. They are now activated and engage the other Unlock Inhibit mechanisms. The direction of the motors is reversed when the doors are unlocked (see Unlock).

Trunk Lock

The Trunk Lock operates in a manner similar to the Door Locks.

5133-0 POWER WINDOWS

2 DOOR

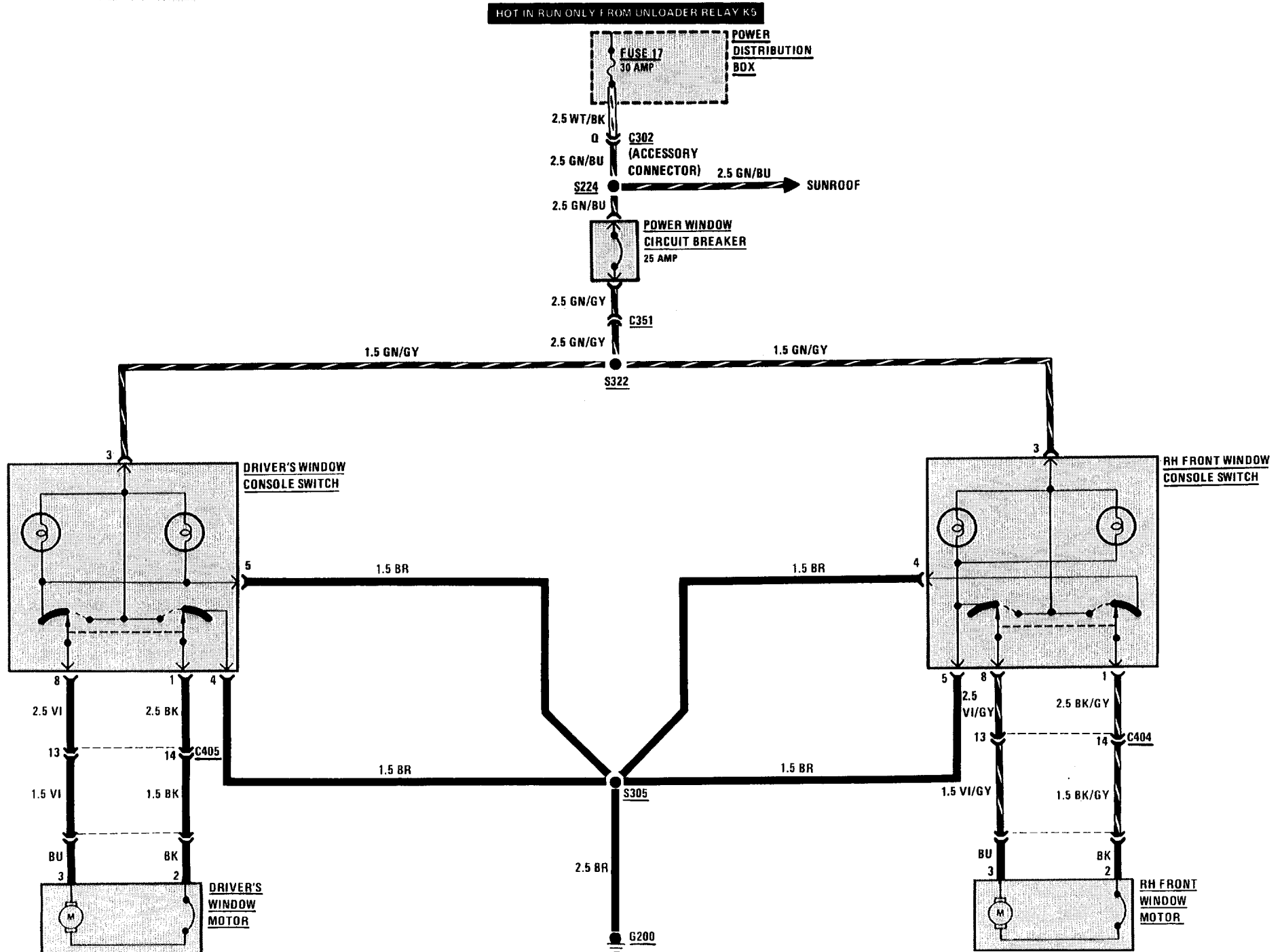

HEATED SEATS

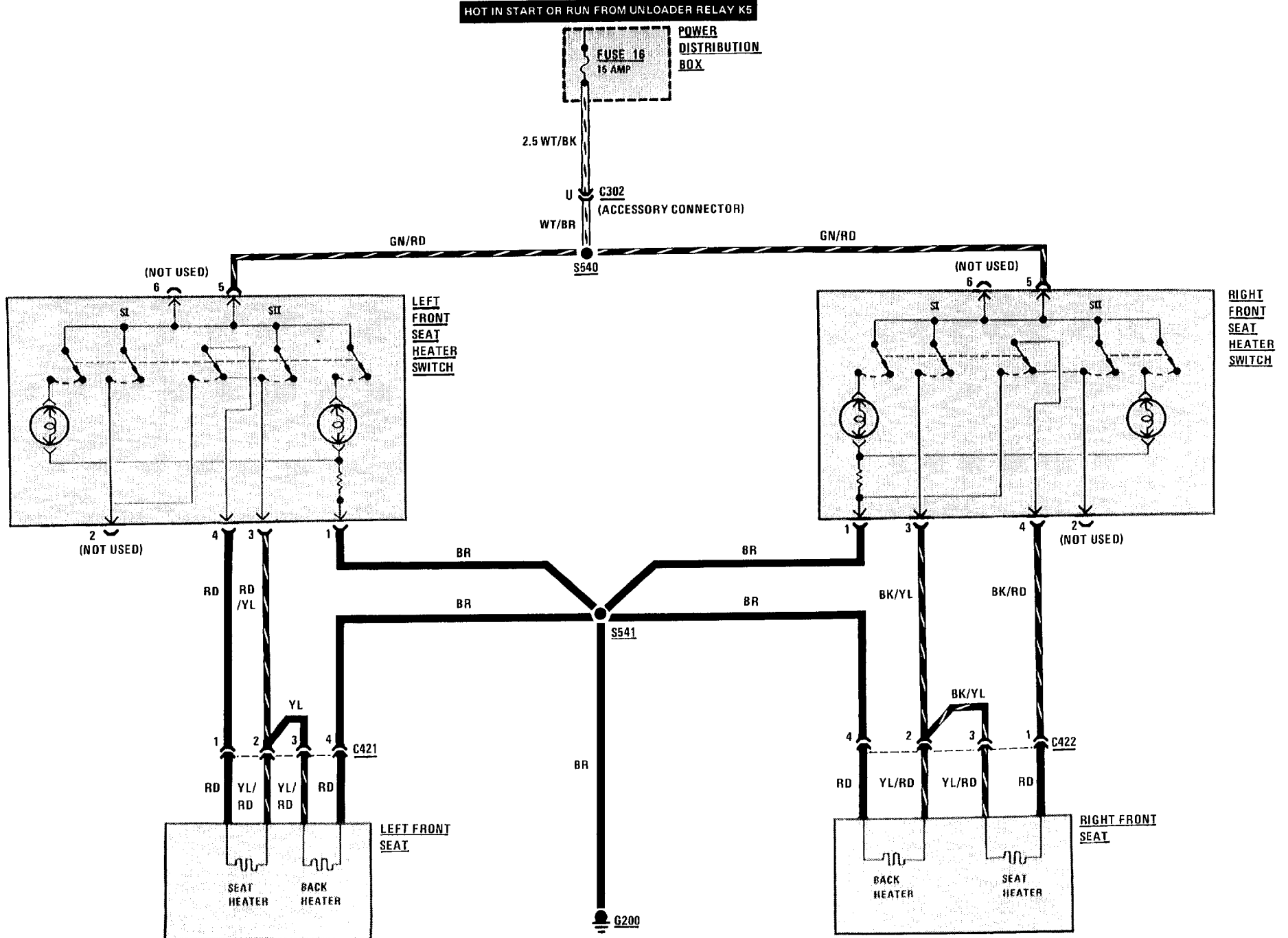

5413-0 SUNROOF

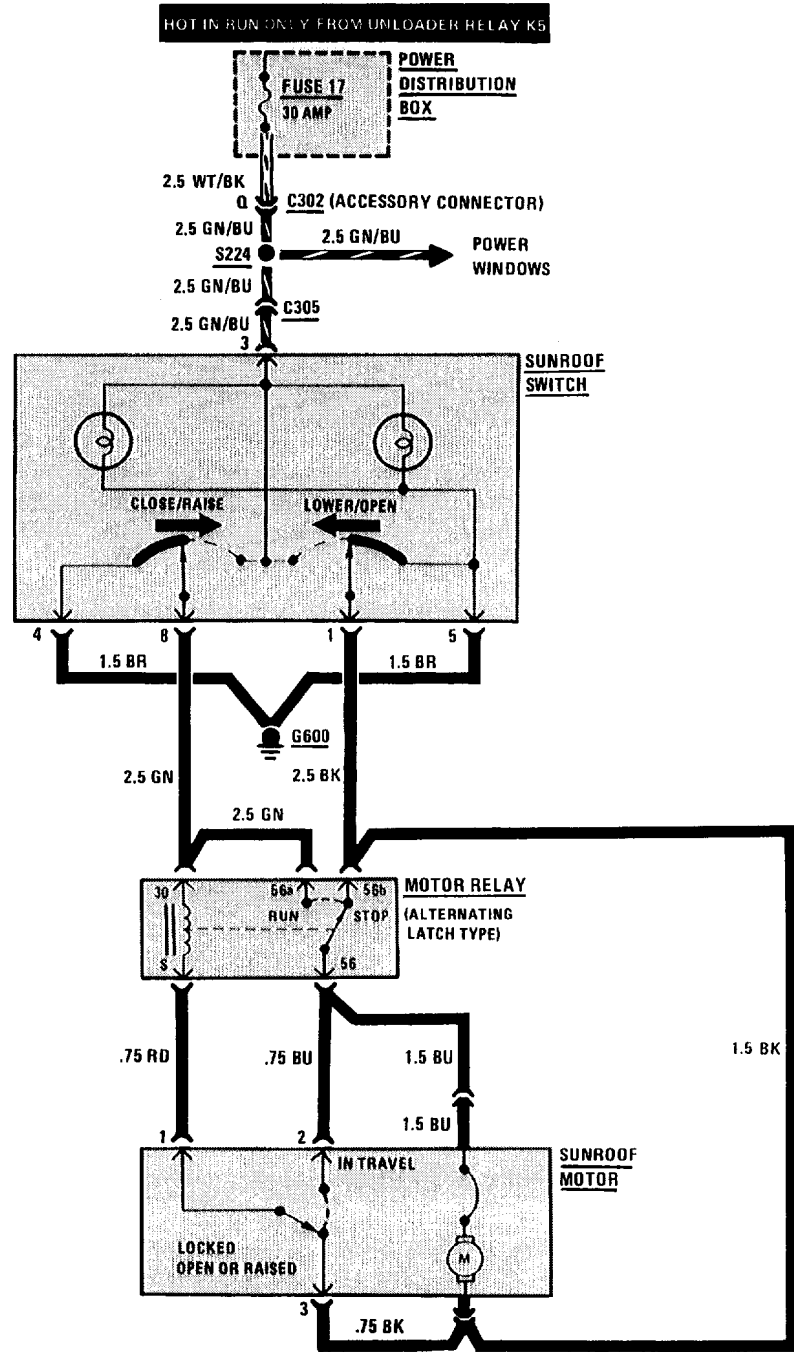

HORNS

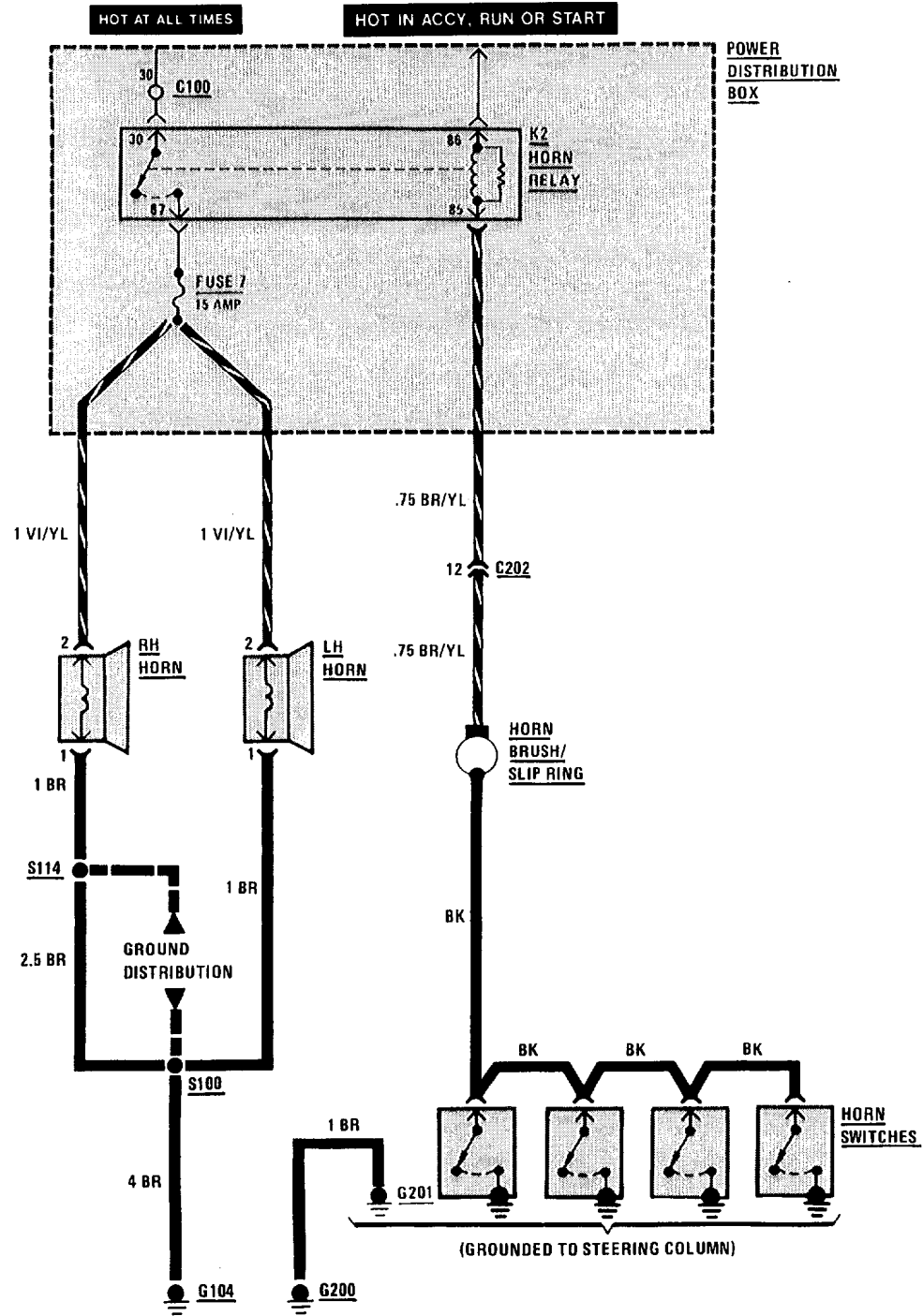

CIGAR LIGHTER/GLOVE BOX LIGHT/AUTO-CHARGING FLASHLIGHT/MAP READING LIGHT

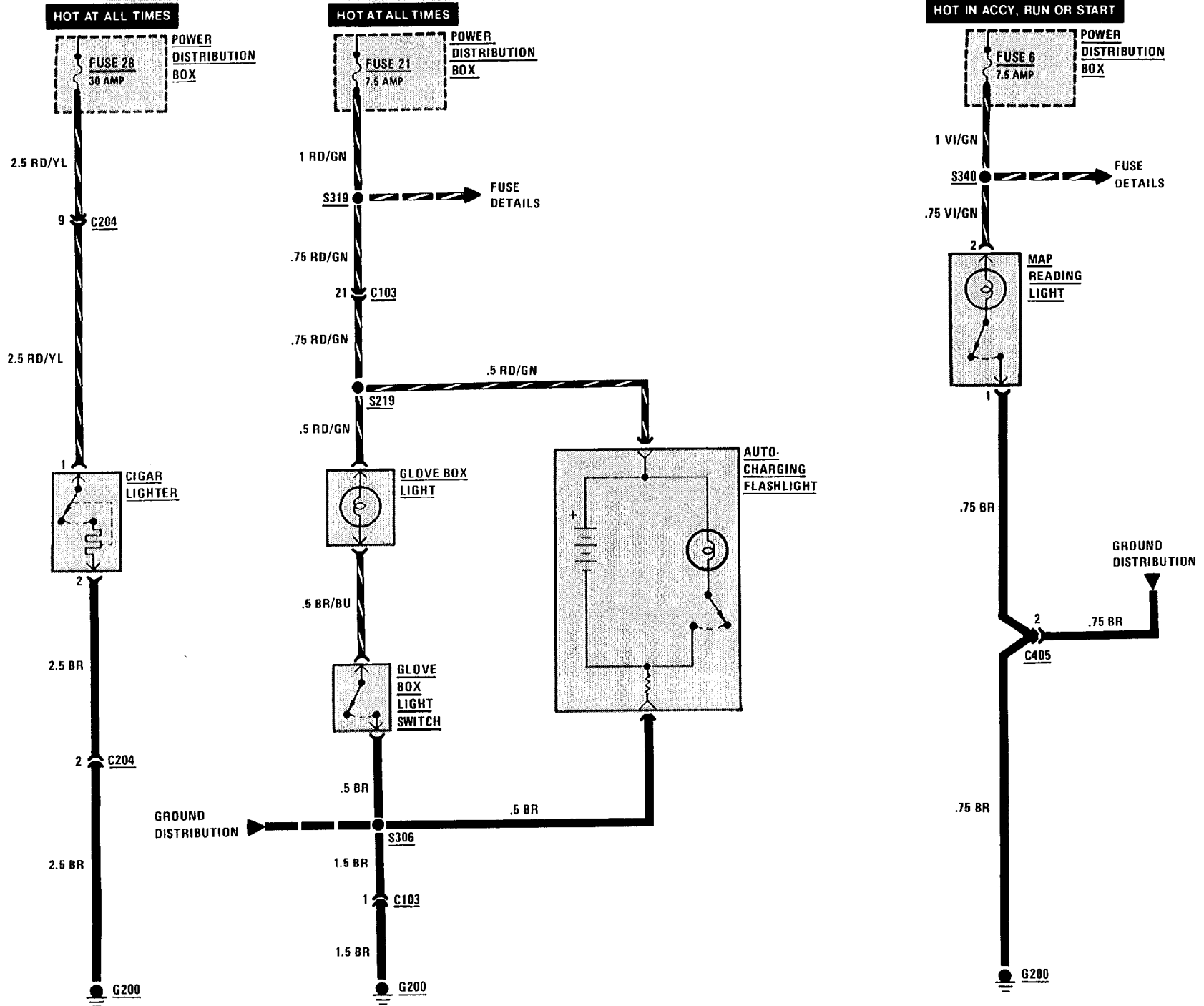

6100-2 BODY ELECTRICAL

REAR DEFOGGER

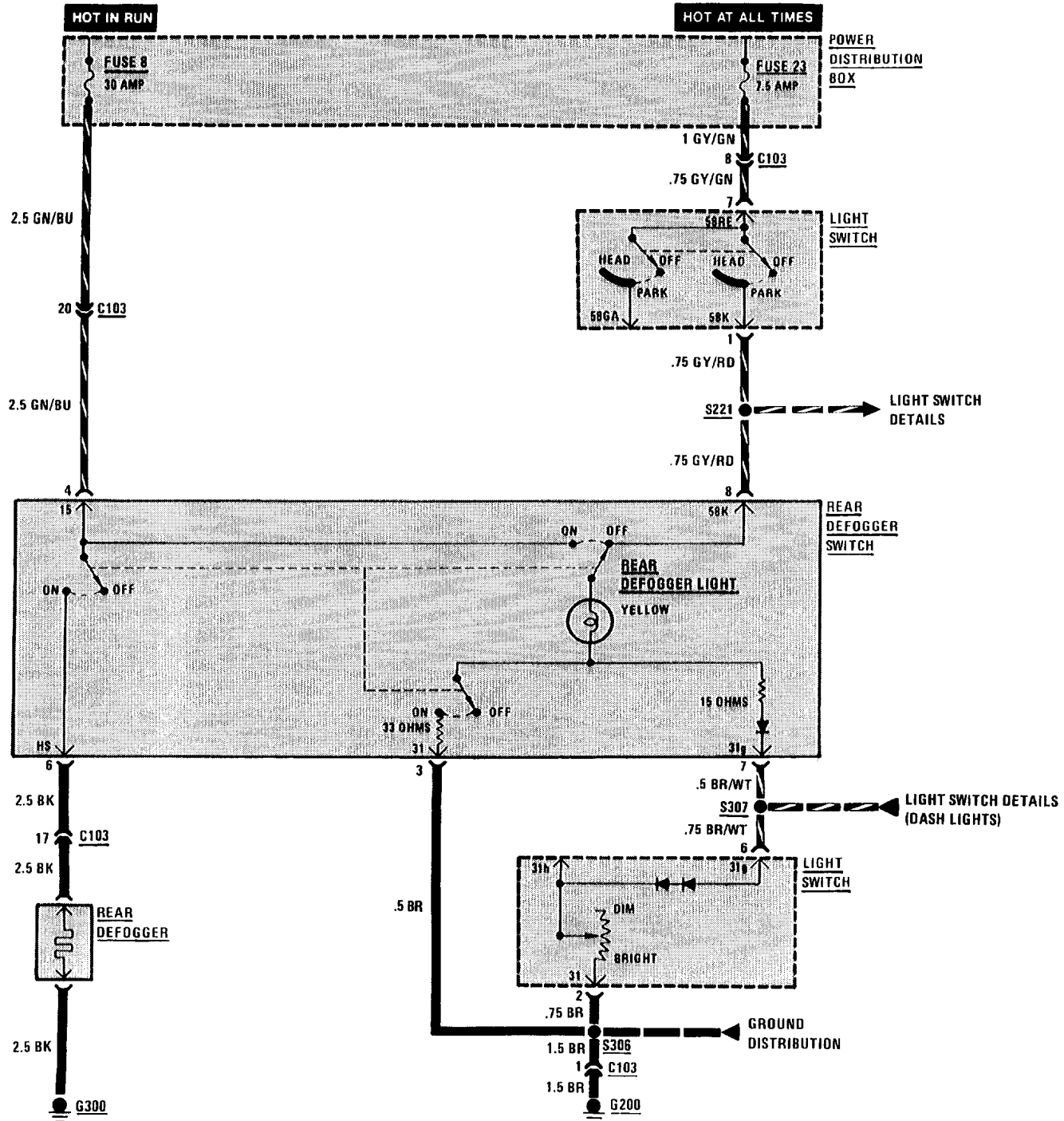

6131-0 IGNITION KEY WARNING/SEATBELT WARNING

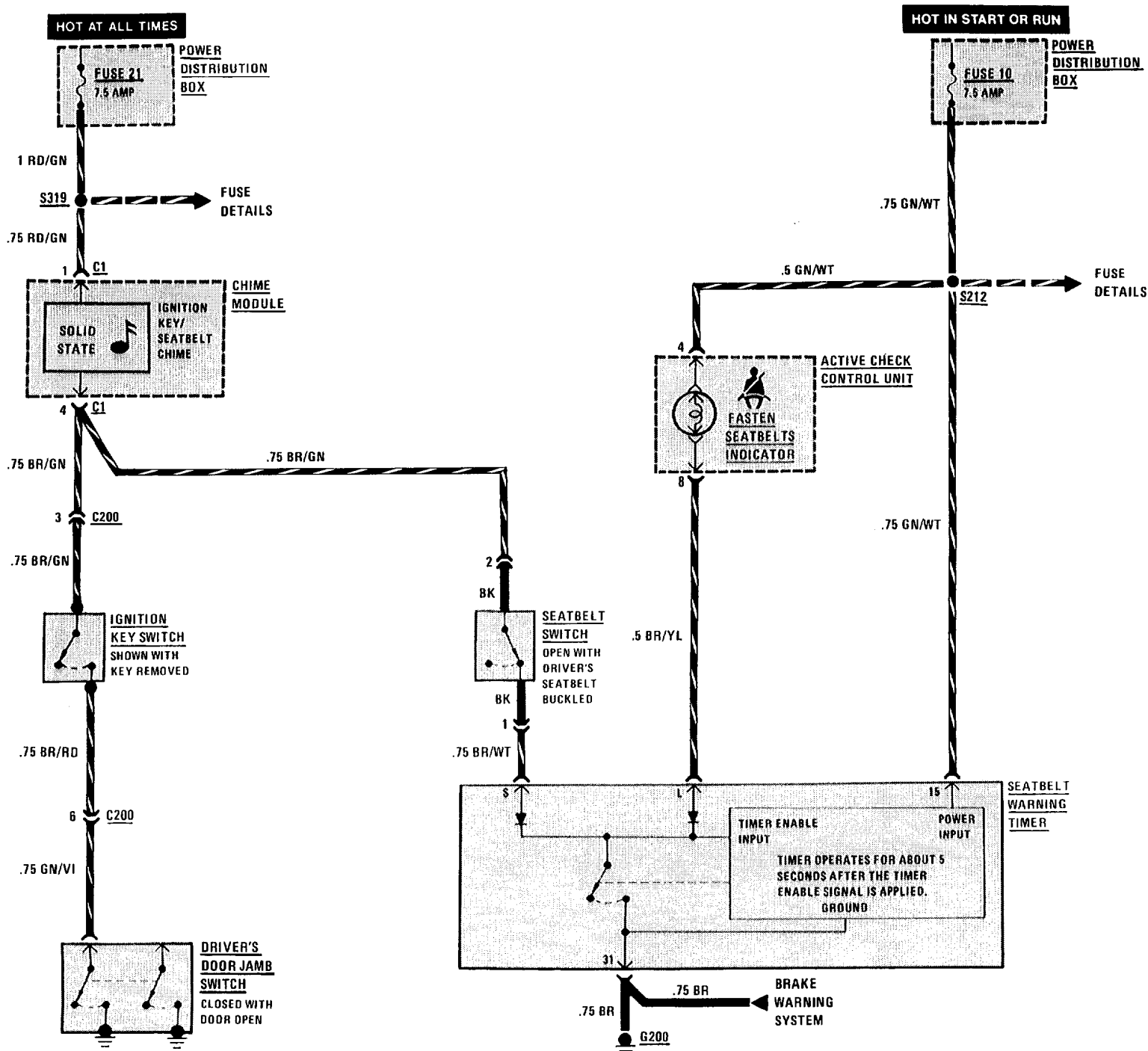

6210-0 INSTRUMENT CLUSTER

SPEEDOMETER/INDICATORS

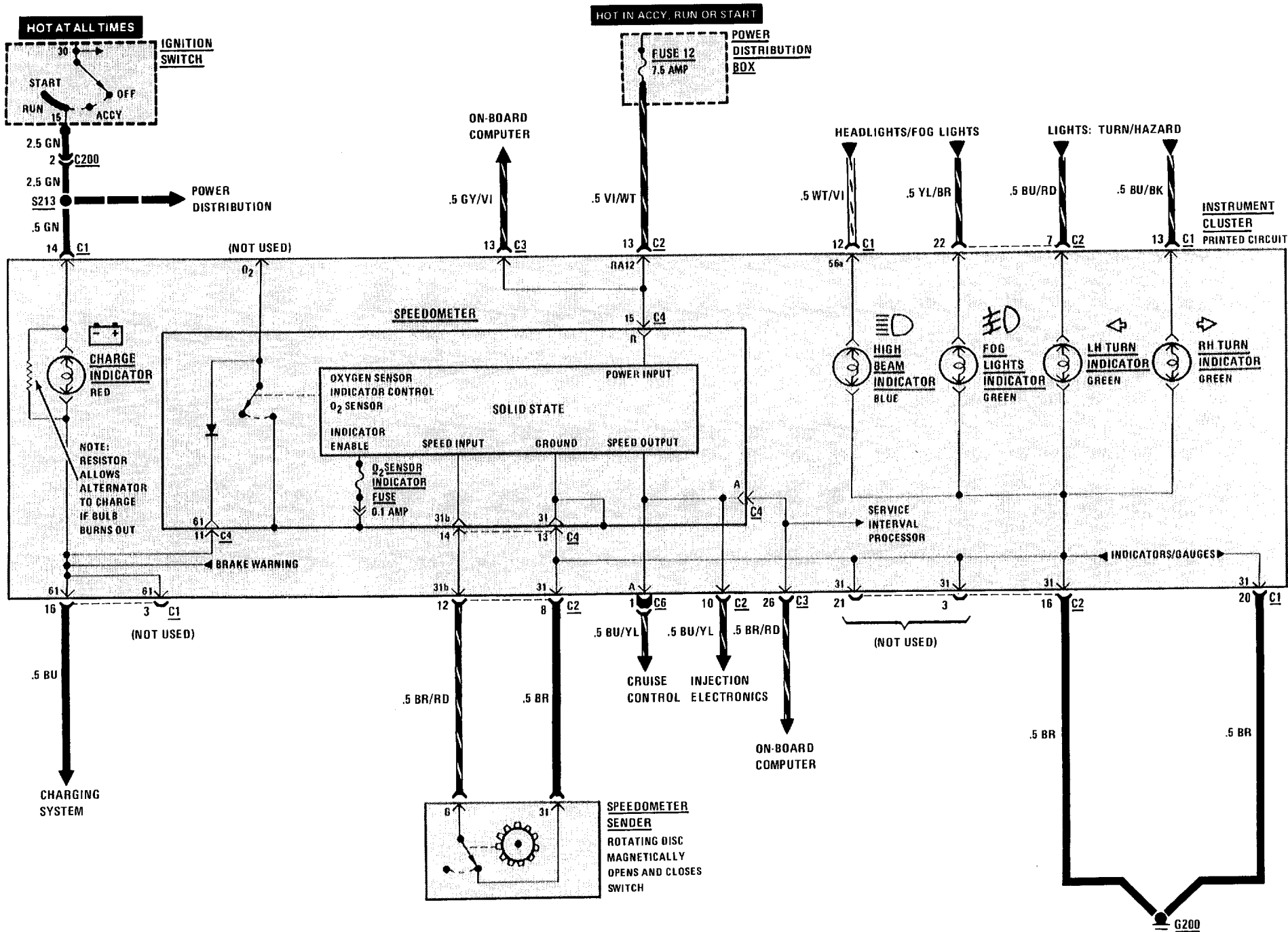

GAUGES/INDICATOR

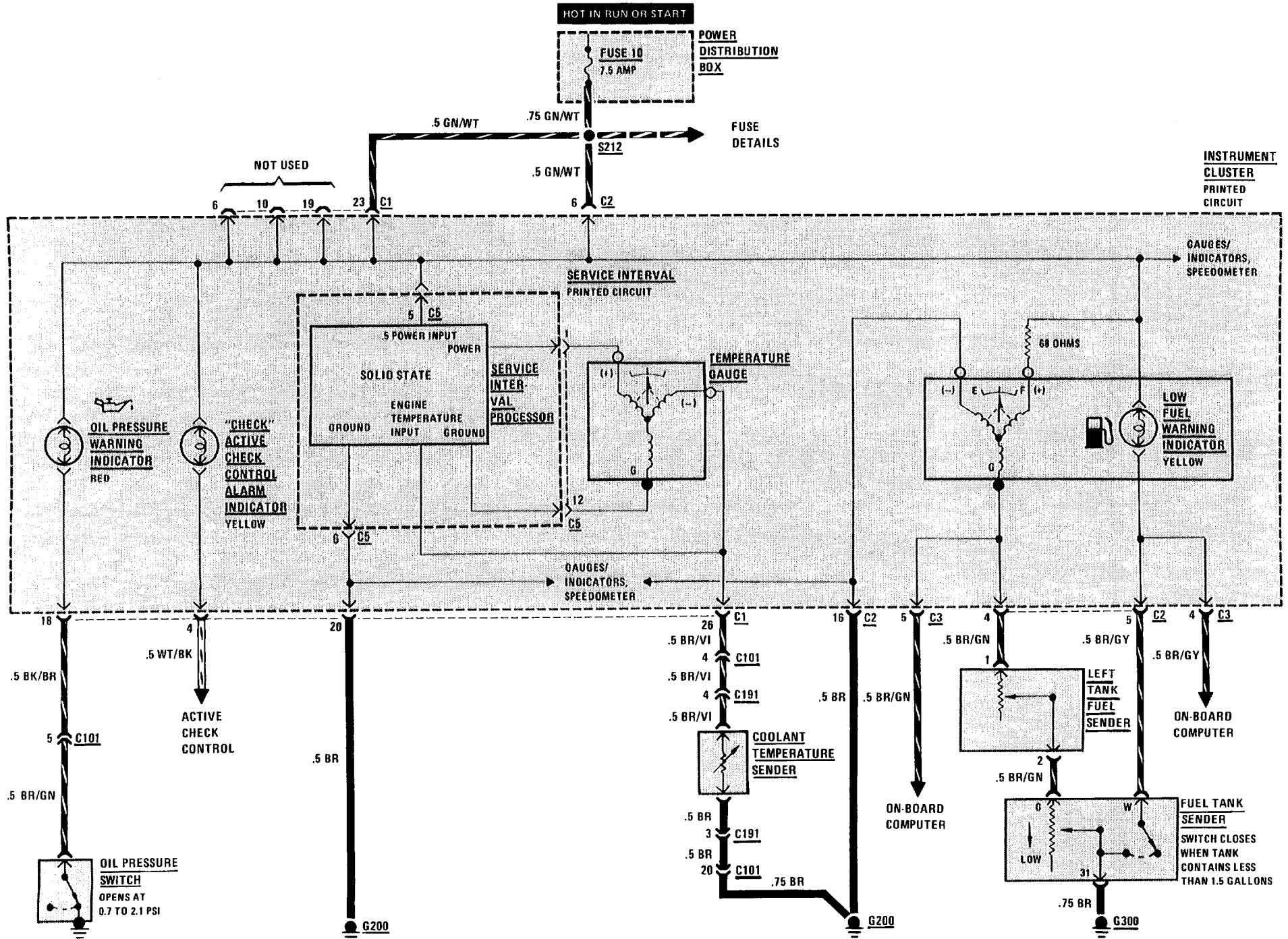

SERVICE INTERVAL INDICATOR

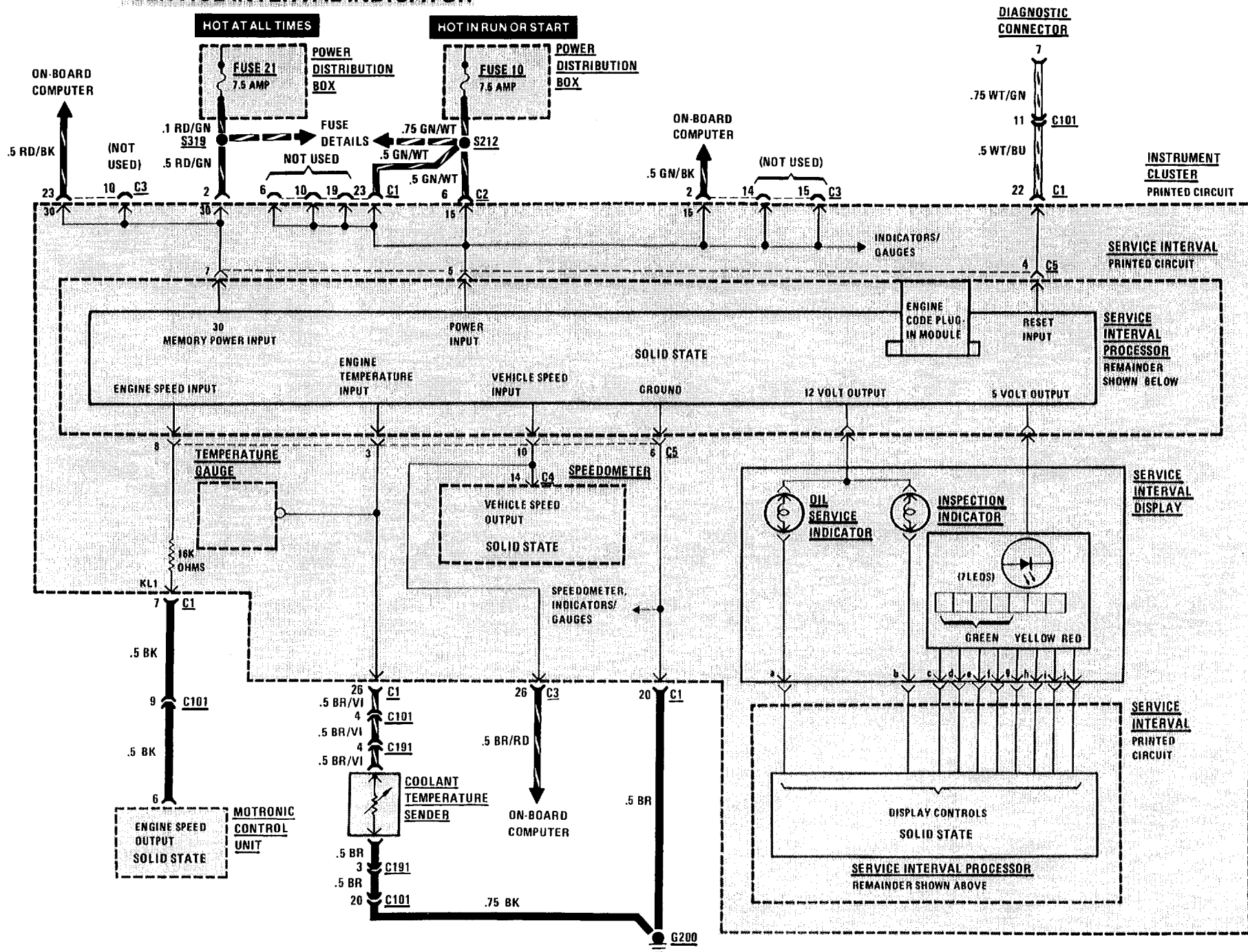

TACHOMETER/FUEL ECONOMY GAUGE

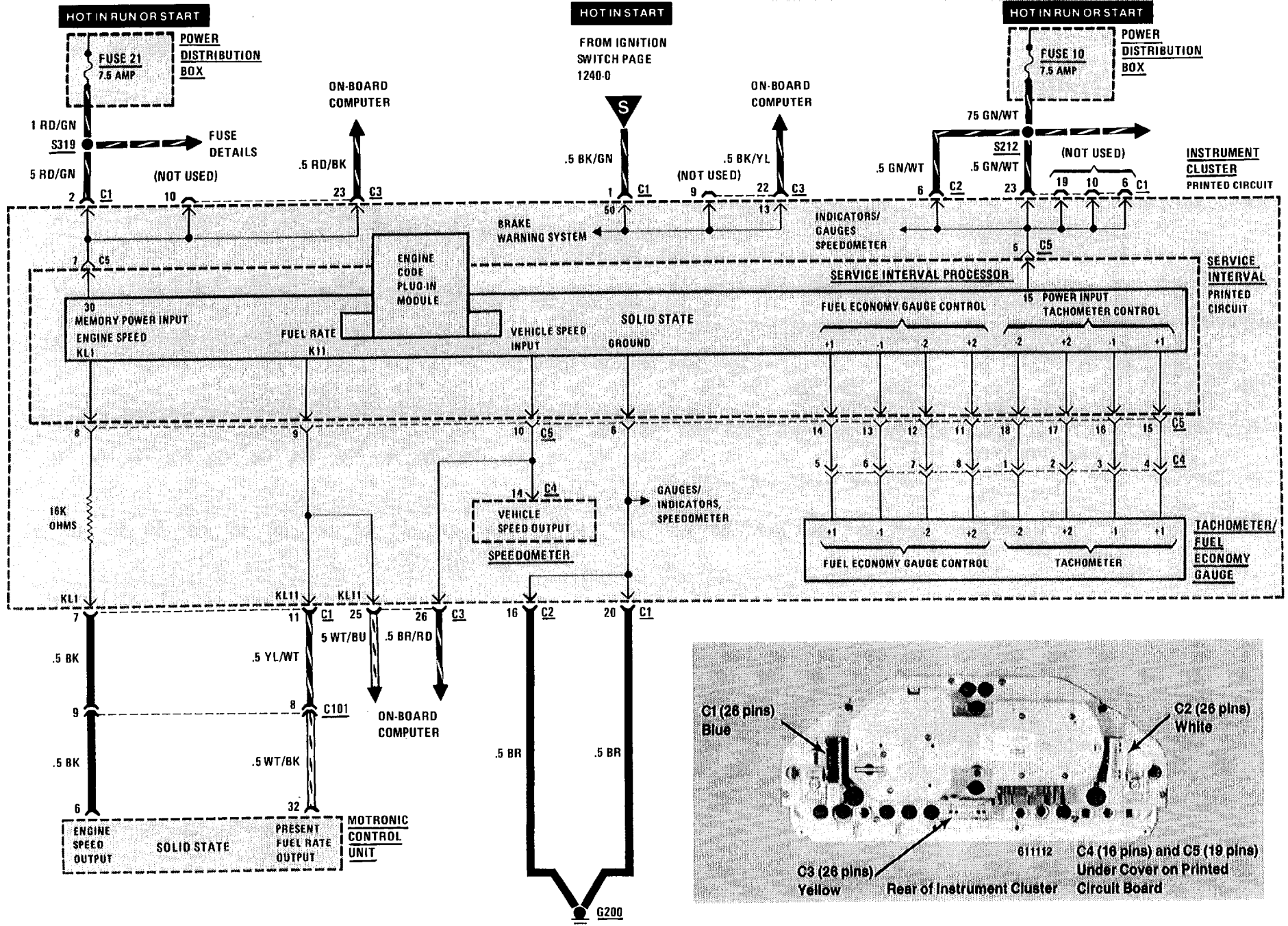

ACTIVE CHECK CONTROL

1. When the Ignition Switch is initially placed in "Run," the Active Check Control Arm Indicator flashes, and the Active Check Control Unit Brake Light LED and panel light illuminate for test purposes. Depressing the brake pedal clears the display.
2. When the Ignition Switch is placed in "RUN," fault monitoring begins. To monitor the low beams, rear lights, or license lights, those circuits must be on. The brake lights are monitored only while the brake pedal is depressed. An exception to this is when all brake light circuits are open. A fault will be indicated with the Ignition Switch in "RUN."
3. When a fault occurs, the alarm indicator flashes, the appropriate LED fault indicator lights, and the panel light goes on for five seconds. Depressing the test button will clear the alarm indicator, but the LED fault indicator remains on.
4. To test the unit, depress the test button. The LED fault indicators and the panel lights should go on.

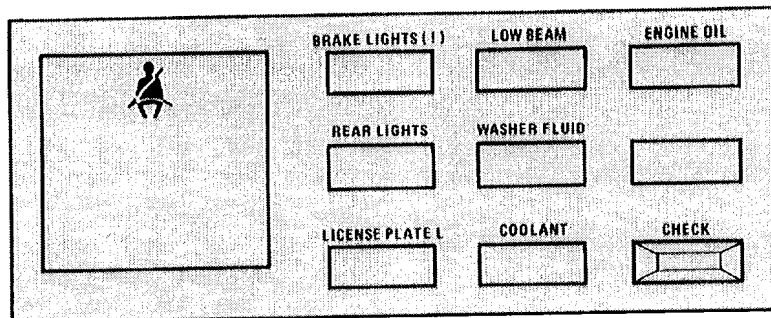
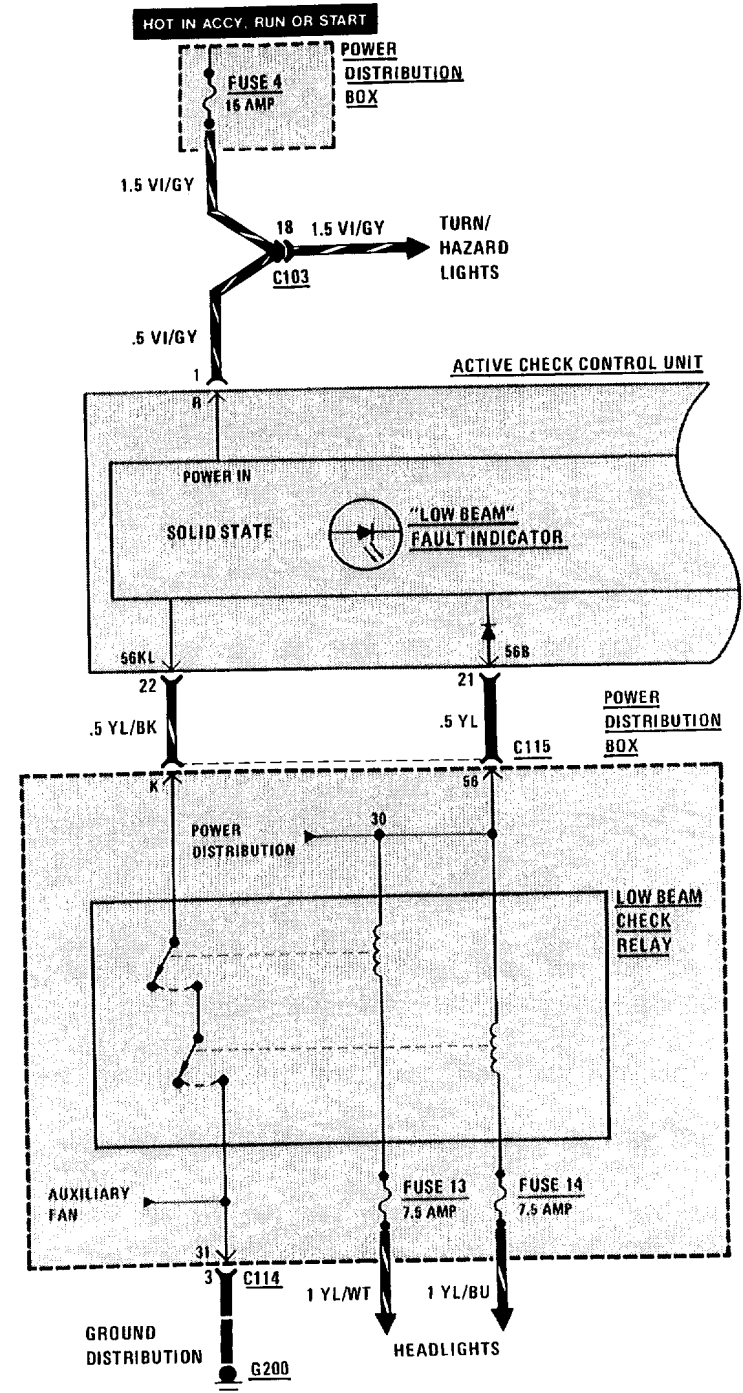
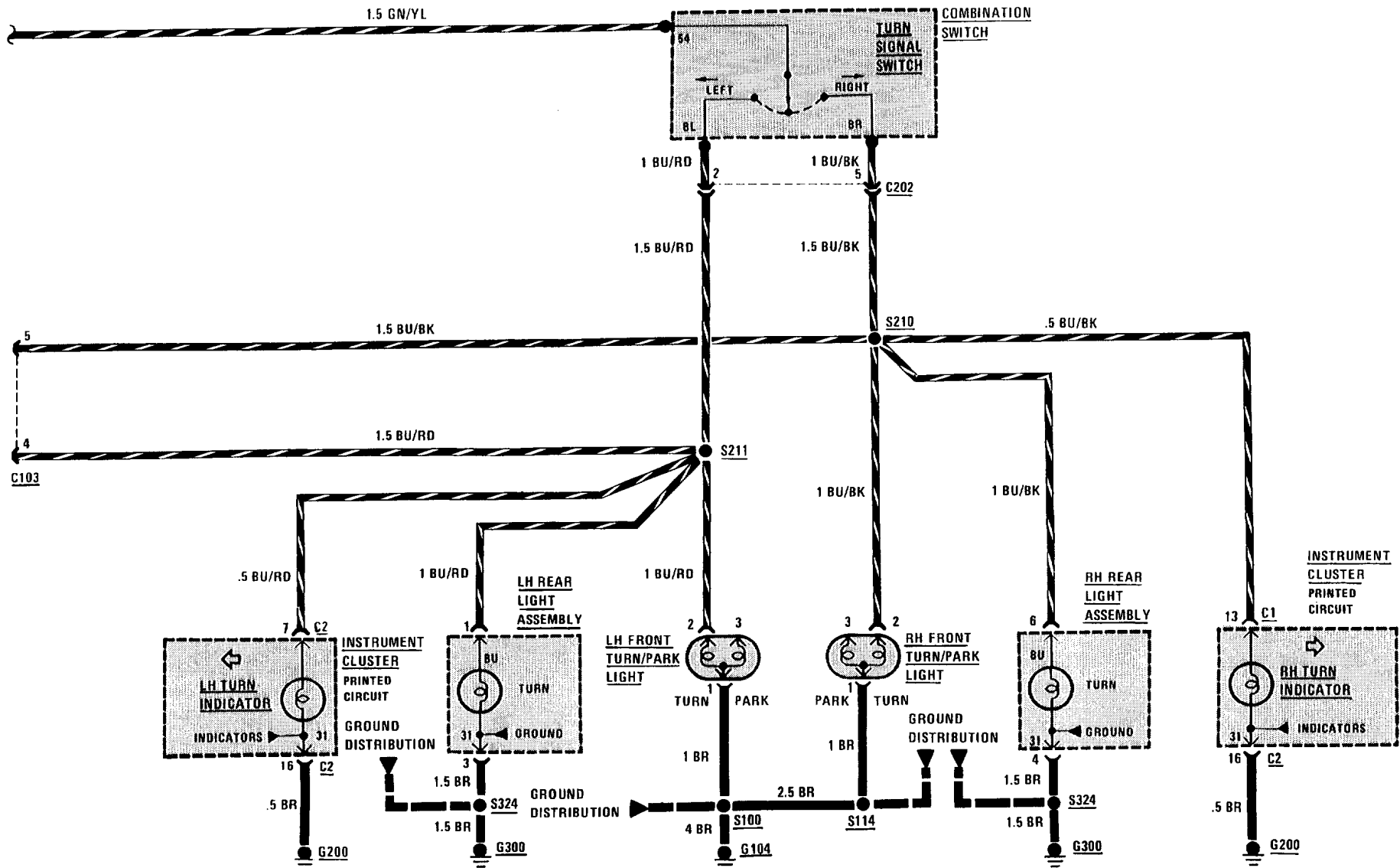

Figure 1 - Active Check Control Unit Above Rear View Mirror



TURN/HAZARD LIGHTS 6313-1



6314-0 PARK/TAIL/FRONT MARKER LIGHTS

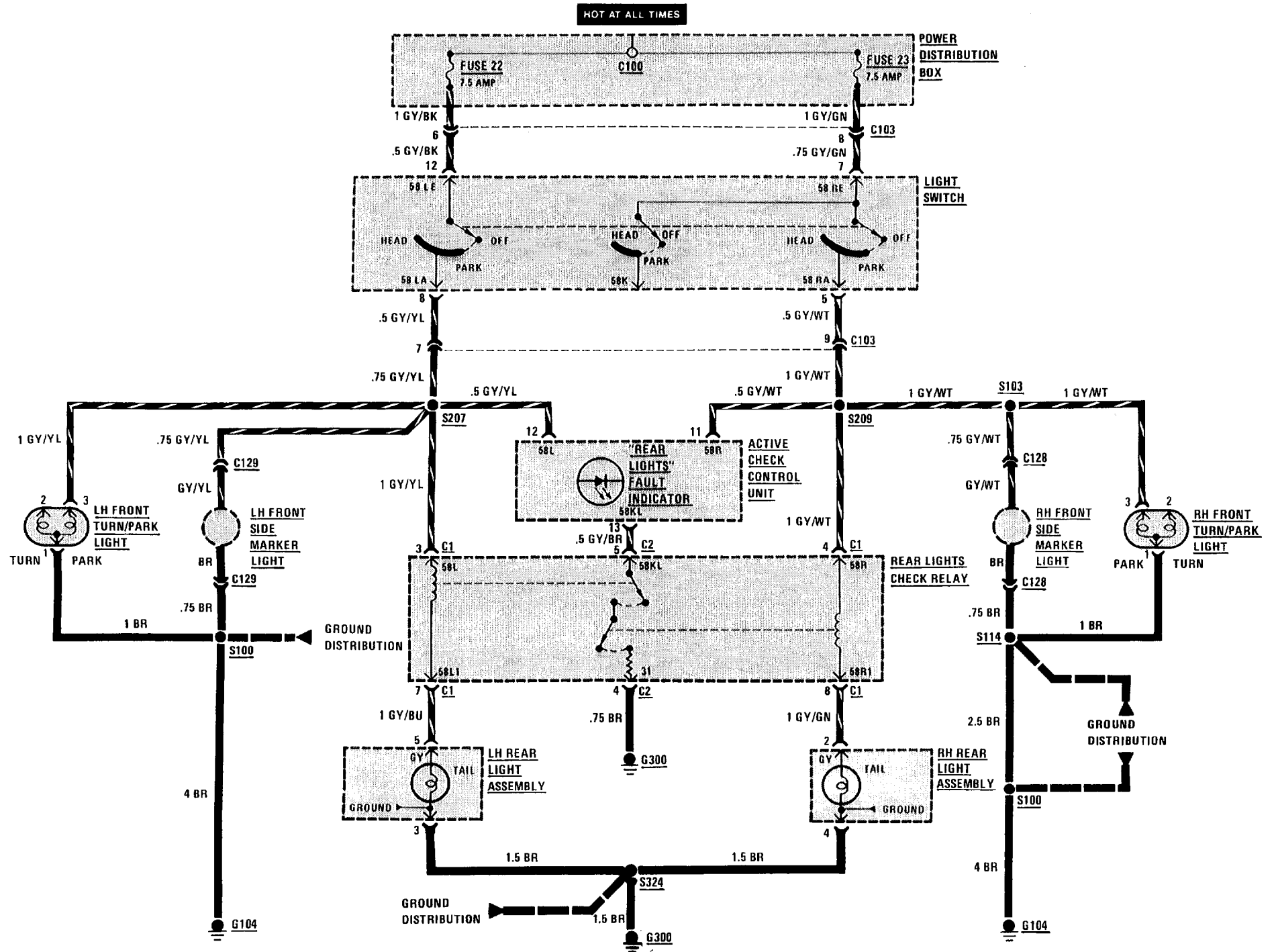

6320-0 REAR MARKER/LICENSE/TRUNK LIGHTS

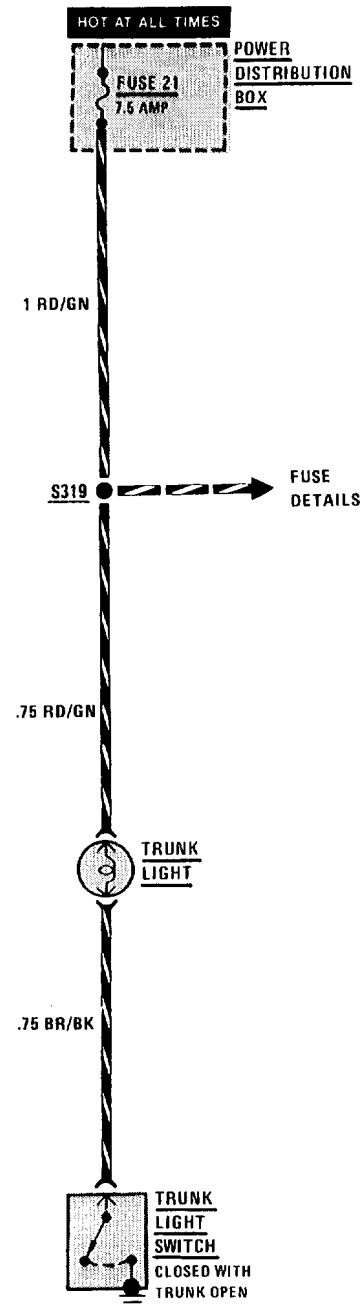
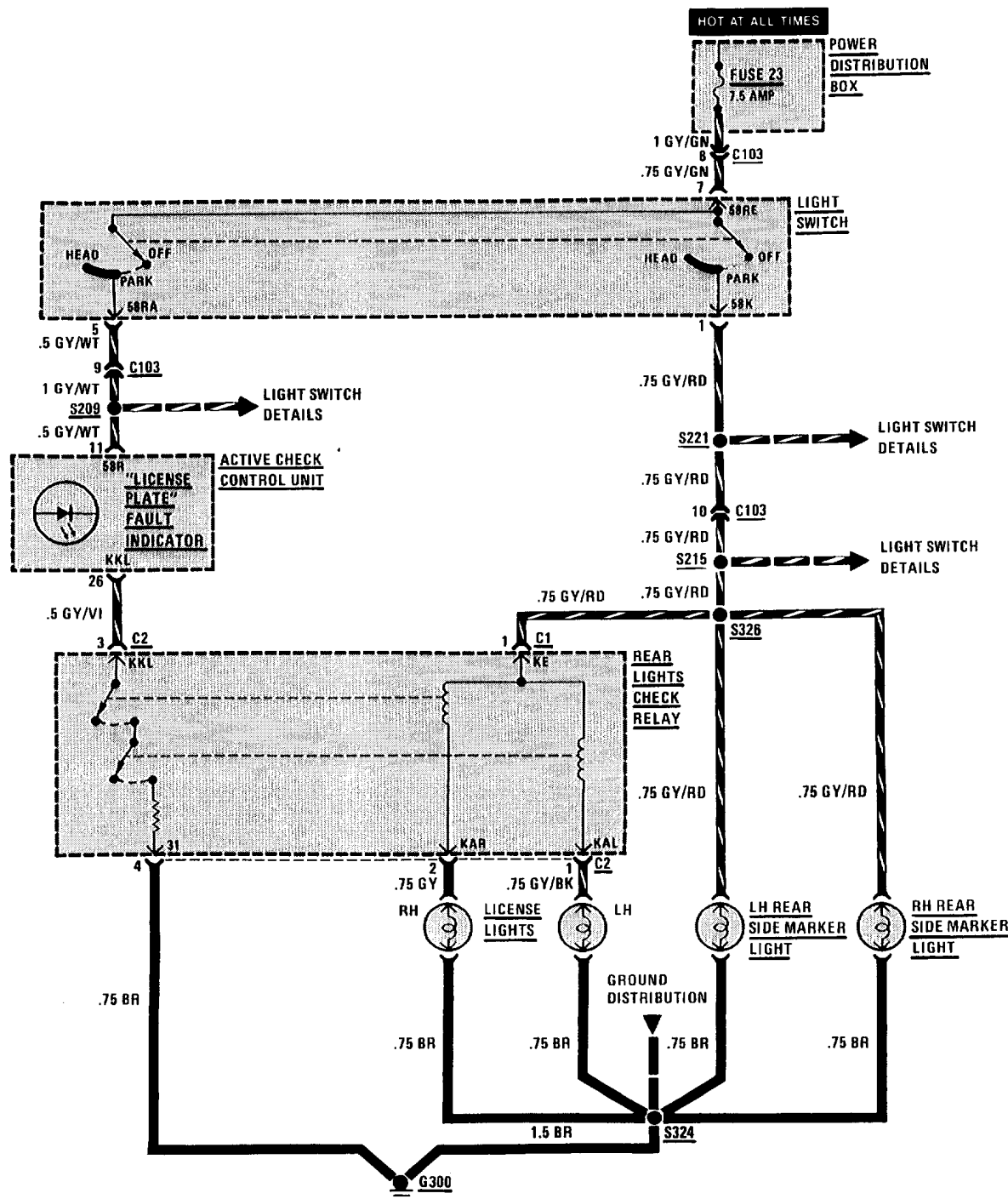

6322-0 BACK UP LIGHTS

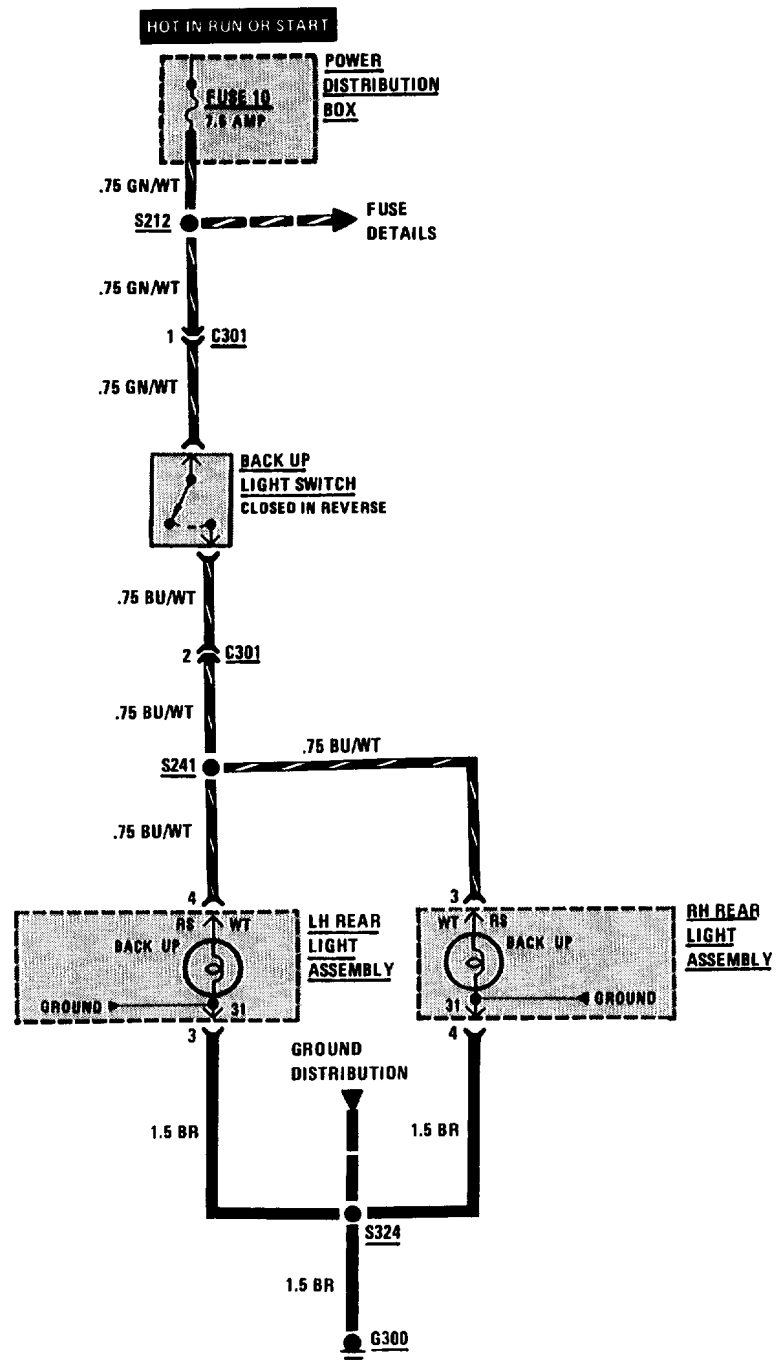

6330-0 INTERIOR LIGHTS

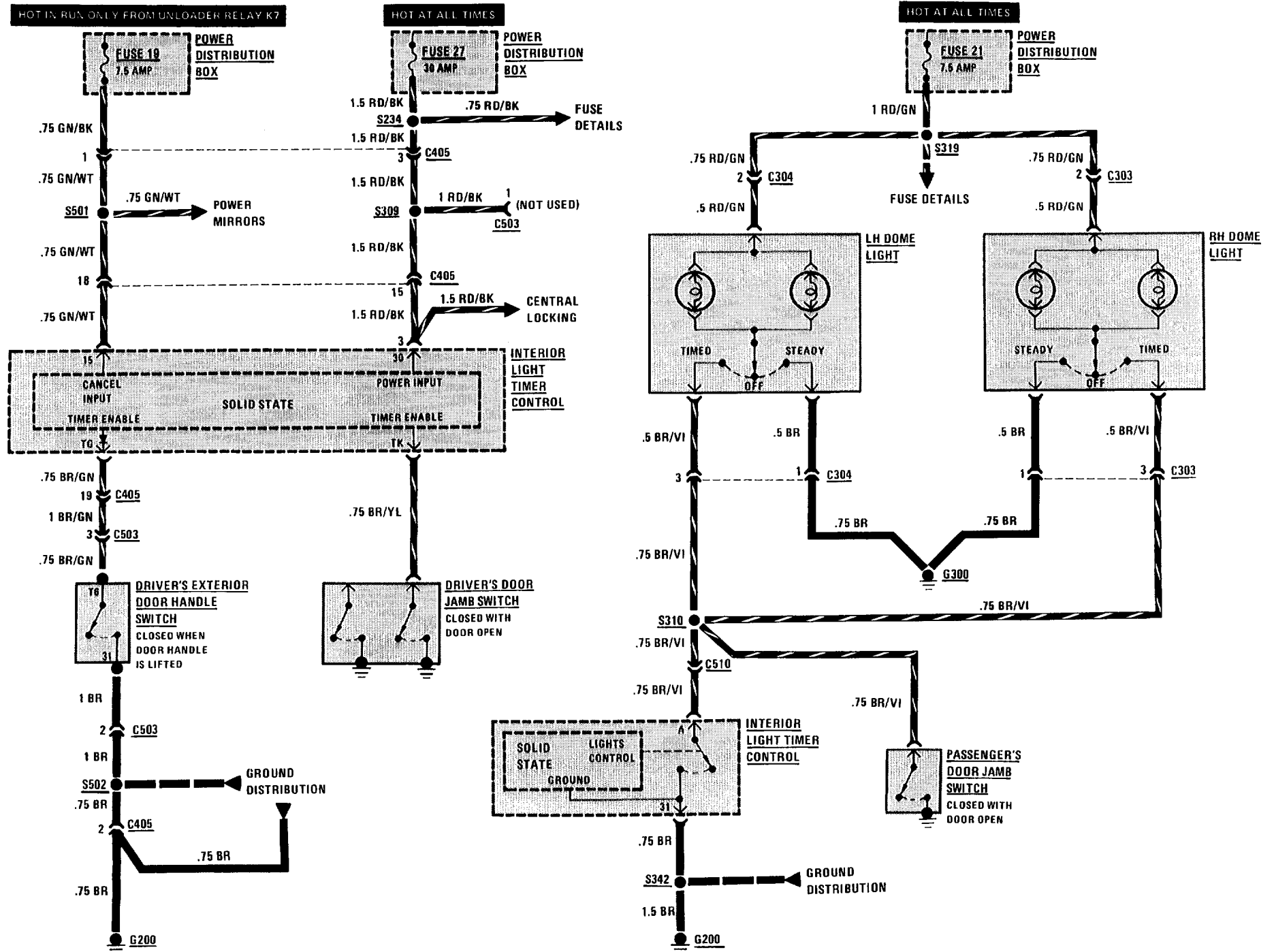

SYSTEM CHECK

This procedure provides an overall check of the Heating and Air Conditioning System. Each of the steps can be performed without disassembly or the use of tools.

Complete this procedure with the temperature outside the car above 60 degrees F (16 degrees C) and the engine warm and running at idle.

SYSTEM CHECK TABLE

SET: Temperature Control fully counterclockwise Upper and Lower Slide Levers to extreme left Center Slide Lever to extreme right Blower Speed Control at 0 (OFF)	
ACTION	NORMAL RESULT
Press Fresh/Recirculating Air Switch (ON). Release A/C button (OFF).	Fresh/Recirculating pushbutton lights. Blower runs slowly.
Rotate Blower Speed Control through steps 1 to 4	Blower speed increases at each step to maximum speed at Step 4
Press Fresh/Recirculating Air Switch to release it (OFF)	Fresh/Recirculating button is no longer lit. Outside air is drawn into car. (The sound of Flap Door Motors may be heard repositioning flaps.)
Rotate Temperature Control at least 1/4 turn clockwise	Air flow becomes warm
Depress A/C button (ON)	A/C button lights. A/C Compressor runs. Auxiliary Cooling Fans runs.
Move Center Slide Lever to the extreme left	A/C button is no longer lighted. A/C Compressor turns off. Auxiliary Cooling Fan turns off.
Move Bottom Slide Lever to the center	A/C button lights. A/C Compressor turns off. Auxiliary Cooling Fan runs.
Press A/C button to release it (OFF)	A/C button is no longer lighted. A/C Compressor turns off. Auxiliary Cooling Fan turns off.
Set Blower Speed Control to 0 (OFF)	Blower turns off

- If all of the steps can be completed as described, the Heating and Air Conditioning System is operating normally.

6411-0 A/C TEMPERATURE CONTROL

HEATING AND AIR CONDITIONING (HOT WATER CONTROL)

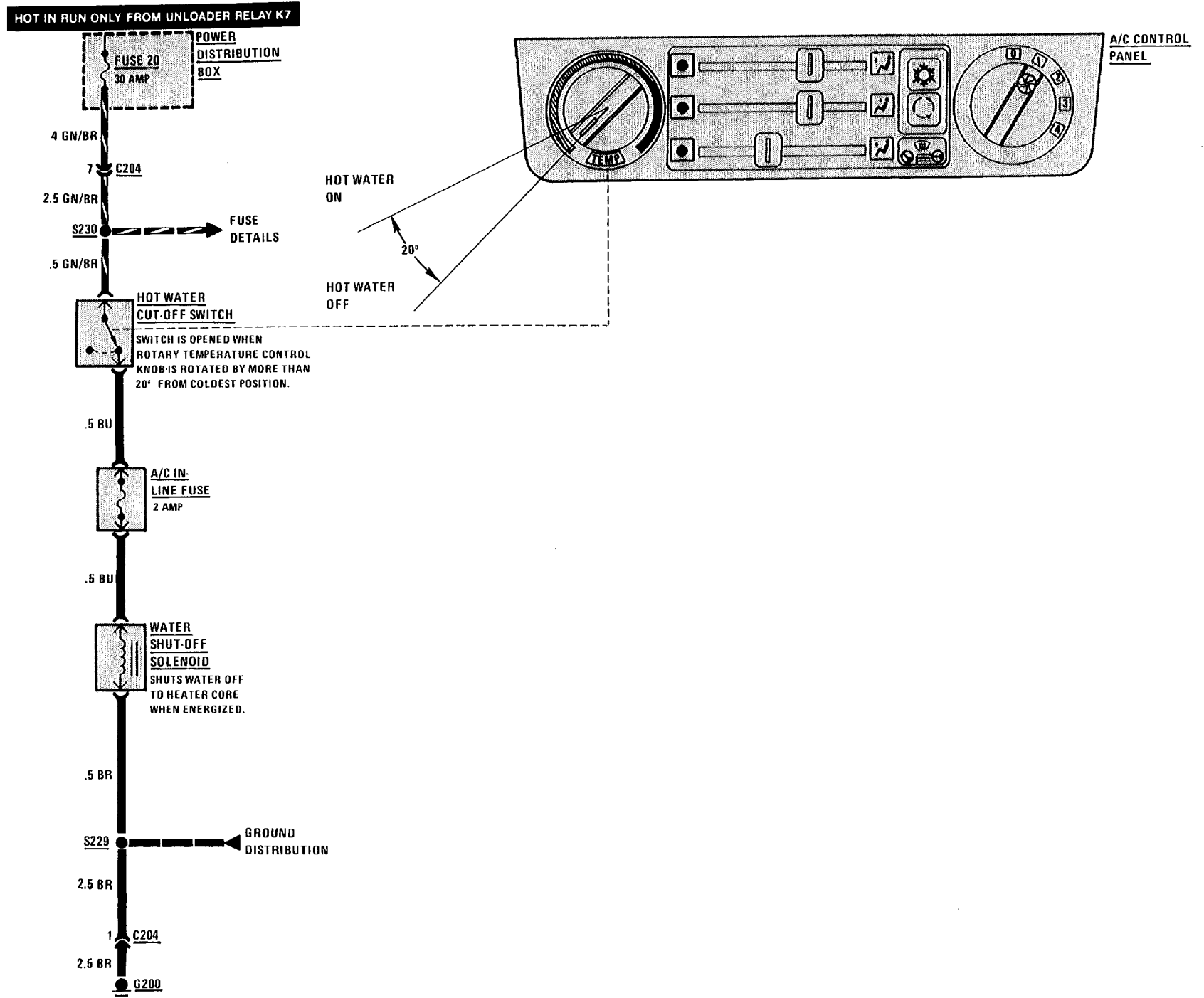

CIRCUIT OPERATION

The Water Shut-Off Solenoid controls the flow of engine coolant through the heater core. When the Solenoid is energized, coolant flow is shut off to allow maximum cooling from the Air Conditioning System. The Water Shut-Off Solenoid is controlled by the Hot Water Cut-Off Switch, which is part of the A/C Control Panel TEMP Control.

Battery voltage is applied through Fuse 20 to the Hot Water Cut-Off Switch when the Ignition Switch is in RUN. The Hot Water Cut-Off Switch is closed when the TEMP Control is rotated fully counterclockwise (coldest position), and opens when the Control is rotated more than 20 degrees in a clockwise direction. When the Switch is closed, battery voltage is applied through the A/C In-Line Fuse to the Water Shut-Off Solenoid. The Solenoid is energized and shuts off the coolant flow through the heater core.

Whenever the Water Shut-Off Solenoid is de-energized, the collapsing magnetic field induces high voltage in the coil. The A/C In-Line Diode, in the 325e, provides a path for the voltage so that it does not damage the contacts of the Hot Water Cut-Off Switch.

The Water Shut-Off Solenoid and A/C In-Line Diode are protected by the A/C In-Line Fuse. If any failures occur in the Solenoid or Diode, the Fuse will isolate them to prevent the failure from affecting other parts of the Heating and Air Conditioning Circuits.

TROUBLESHOOTING HINTS

- Try the following checks before doing the System Diagnosis.
- 1. Check that Water Shut-Off Solenoid connector is firmly seated.
- 2. Check the A/C In-Line Fuse. If fuse is blown, check for a shorted A/C In-Line Diode.
- Go to Heating and Air Conditioning (6410A-0) System Check for a guide to normal operation.
- Go to System Diagnosis for diagnostic tests.

SYSTEM DIAGNOSIS

- Do the following test if the Water Shut-Off Solenoid does not operate normally.

WATER SHUT-OFF SOLENOID TEST (TABLE 1)

Measure: VOLTAGE At: WATER SHUT-OFF SOLENOID CONNECTOR (Disconnected) Conditions: • Ignition Switch: RUN • A/C Control Panel TEMP Control: FULLY COUNTERCLOCKWISE		
Measure Between	Correct Voltage	For Diagnosis
BU & Ground	Battery	See 1
BU & BR/RD or BR	Battery	See 2
• Rotate A/C Control Panel TEMP Control to Mid Position		
BU & Ground	0 Volts	See 3

(Continued in next column)

(Continued from previous column)

- If all voltages are correct, replace the Water Shut-Off Solenoid.
- 1. Check the BU wire and A/C In-Line Fuse for an open. If fuse is open, check that A/C In-Line Diode is not shorted. If it is, replace it. If wire, Fuse and Diode are good, go to Table 2.
- 2. Check the BR/RD or BR wire for an open to ground. Check that connector C204 is properly mated.
- 3. Check BU wire for a wire to wire short to voltage. If wire is good, replace the A/C Control Panel TEMP Control.

WATER SHUT-OFF SOLENOID TEST (TABLE 2)

Measure: VOLTAGE At: HOT WATER CUT-OFF SWITCH CONNECTOR (Disconnected) Conditions: • Ignition Switch: RUN • Water Shut-Off Solenoid: CONNECTED		
Measure Between	Correct Voltage	For Diagnosis
GN/BR & Ground	Battery	See 1
GN/BR & BU	Battery	See 2
• If both voltages are correct, replace the A/C Control Panel TEMP Control.		
1. Check the GN/BR wire for an open back to Fuse 20.		
2. Check the BU wire for an open.		

6413-0 A/C BLOWER CONTROLS

HEATING AND AIR CONDITIONING (BLOWER CONTROLS)

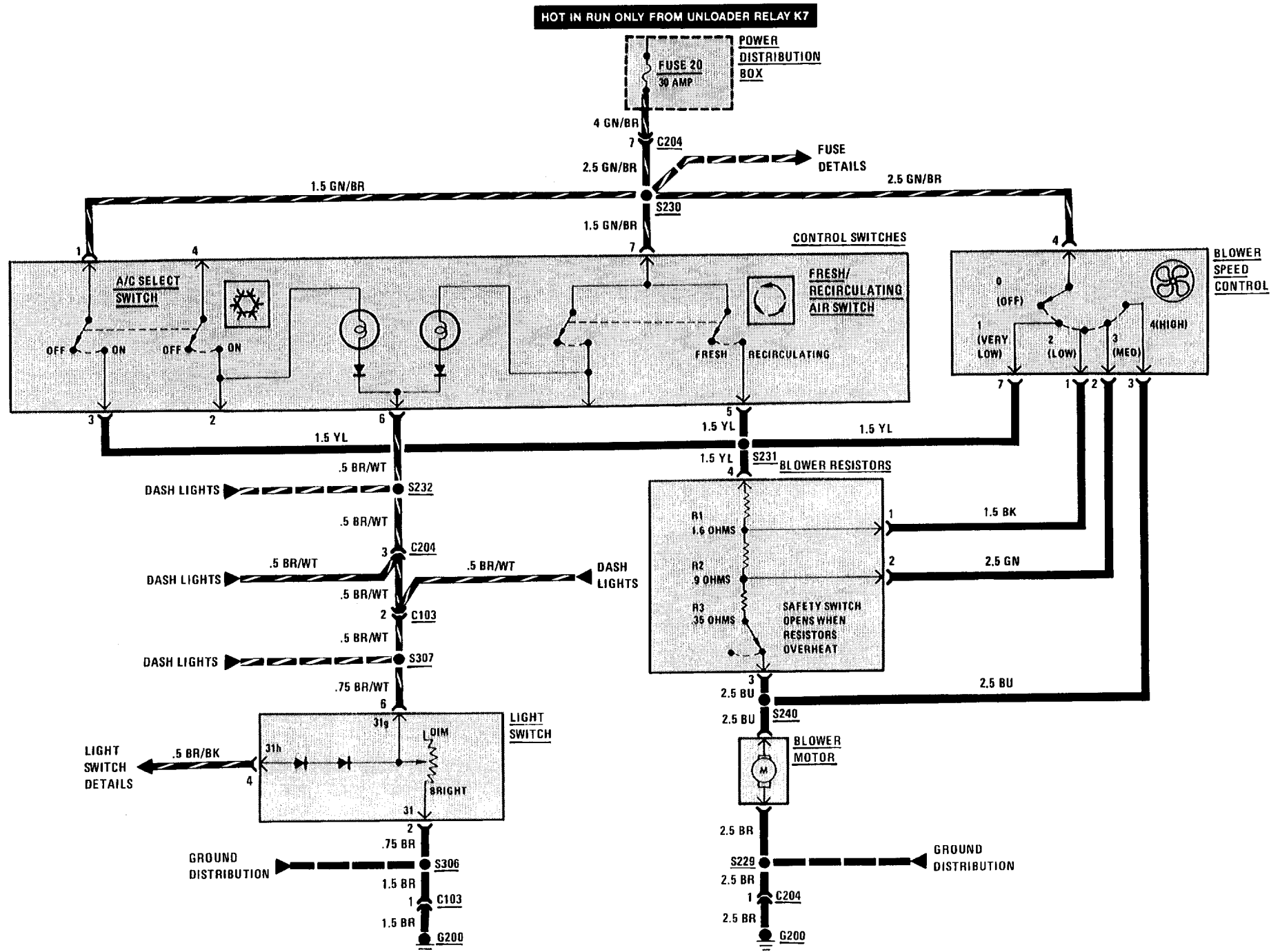

CIRCUIT OPERATION

With the Ignition Switch in RUN, battery voltage is applied to the Control Switches and the Blower Speed Control through the GN/BR wires. If either the A/C Select Switch or the Fresh/Recirculating Air Switch are ON or the Blower Speed Control is in position 1, battery voltage is applied through the YL wire to the Blower Resistors and the Blower Motor.

The Blower Motor is a variable speed motor which runs at a speed proportional to the voltage applied to it. With all of the Blower Resistors in the circuit, the voltage applied to the motor is reduced so the motor runs at a low speed.

As the Blower Speed Control is moved through positions 2 and 3, some of the resistors are bypassed, allowing more voltage to be applied to the Blower Motor, which then runs at a higher speed. When the Blower Speed Control is moved to position 4, battery voltage is applied directly to the Blower Motor, which then runs at maximum speed.

The Blower Resistors dissipate heat because of the current flowing through them. They are cooled by the air flow from the blower. If there is insufficient air flow to cool the resistors, the safety switch will open, shutting the Blower Motor off until the resistors have cooled.

TROUBLESHOOTING HINTS

- Try the following checks before doing the System Diagnosis.
- 1. Check Fuse 20 by visual inspection.
- 2. If Blower will run in high only, check the Blower Resistors' Safety Switch for an open.

- Go to Heating and Air Conditioning (6410-0) System Check for a guide to normal operation.
- Go to System Diagnosis for diagnostic tests.

SYSTEM DIAGNOSIS

- Do the tests listed for your symptom in the Symptom Table below.
- Tests follow the Symptom Table.

SYMPTOM TABLE

SYMPTOM	DO TEST
Blower Motor does not run in any speed setting	B
Blower runs only in HIGH (does not run in any other speed setting)	B
Blower does not run in some modes	A
Blower does not run with A/C ON or in Recirculating mode	A
A/C Select Switch or Fresh/Recirculating Air Switch does not light	A

A: CONTROL SWITCH VOLTAGE TEST

Measure: VOLTAGE At: CONTROL SWITCHES CONNECTOR (Disconnected) Conditions: <ul style="list-style-type: none"> • Ignition Switch: RUN • Blower Speed Control: OFF 		
Measure Between	Correct Voltage	For Diagnosis
1 (GN/BR) & Ground	Battery	See 1
1 (GN/BR) & 3 (YL)	Battery	See 2 & 4
7 (GN/BR) & Ground	Battery	See 1
7 (GN/BR) & 5 (YL)	Battery	See 2 & 4
7 (GN/BR) & 6(BR/WT)	Battery	See 3
<ul style="list-style-type: none"> • If all voltages are correct, do Test B. 1. Check the GN/BR wire for an open. 2. Check the YL wire for an open. 3. Check the BR/WT wire for an open. 4. If voltage is not present between the GN/BR wire and both the YL wires (terminals 3 and 5), do Test B. 		

B: BLOWER SPEED CONTROL TEST

Measure: VOLTAGE AT: BLOWER SPEED CONTROL CONNECTOR (Disconnected) Conditions: <ul style="list-style-type: none"> • Ignition Switch: RUN • A/C Select Switch: ON (Depressed) • Fresh/Recirculating Air Switch: FRESH (Not Depressed) 		
Measure Between	Correct Voltage	For Diagnosis
4 (GN/BR) & Ground	Battery	See 1
7 (YL) & Ground	Battery	See 2
<ul style="list-style-type: none"> • A/C Select Switch: OFF (Not Depressed) 		
7 (YL) & Ground	0 Volts	See 3
4 (GN/BR) & 7 (YL)	Battery	See 4, 8, 9, & 10
4 (GN/BR) & 1 (BK)	Battery	See 5, 8, 9, & 10
4 (GN/BR) & 2 (GN)	Battery	See 6, 8, 9, & 10
4 (GN/BR) & 3 (BU)	Battery	See 7 & 10
<ul style="list-style-type: none"> • If all voltages are correct, replace the Blower Motor. <ol style="list-style-type: none"> 1. Check the GN/BR wire for an open. 2. Check the YL wire for an open between Blower Speed Control and splice S231. 3. Check the YL wire for a wire to wire short to voltage. 		

(Continued in next column)

(Continued from previous column)

<ol style="list-style-type: none"> 4. Check the YL wire for an open between splice S231 and the Blower Resistors. 5. Check the BK wire for an open. 6. Check the GN wire for an open. 7. Check the BU wire for an open. 8. If voltage is not present at the YL wire, but is present at the GN wire or BK wire, replace the Blower Resistors. 9. If voltage is not present at the YL, BK or GN wires, check for an open Blower Resistors' Safety Switch. 10. If voltage is not present at the YL, BK, GN and BU wires, do Test C.

C: BLOWER MOTOR TEST

Measure: VOLTAGE At: BLOWER MOTOR CONNECTOR (Disconnected) Conditions: <ul style="list-style-type: none"> • Ignition Switch: RUN • A/C Select Switch: ON • Blower Speed Control: HIGH 		
Measure Between	Correct Voltage	For Diagnosis
BU & Ground	Battery	See 1
BU & BR	Battery	See 2
<ul style="list-style-type: none"> • If both voltages are correct, replace the Blower Motor. <ol style="list-style-type: none"> 1. Check the BU wire for an open. If wire is good, recheck Test B. 2. Check the BR wire to ground G200 for an open. 		

6421-0 A/C AIR DELIVERY CONTROL

HEATING AND AIR CONDITIONING (FRESH/RECIRCULATING AIR CONTROLS)

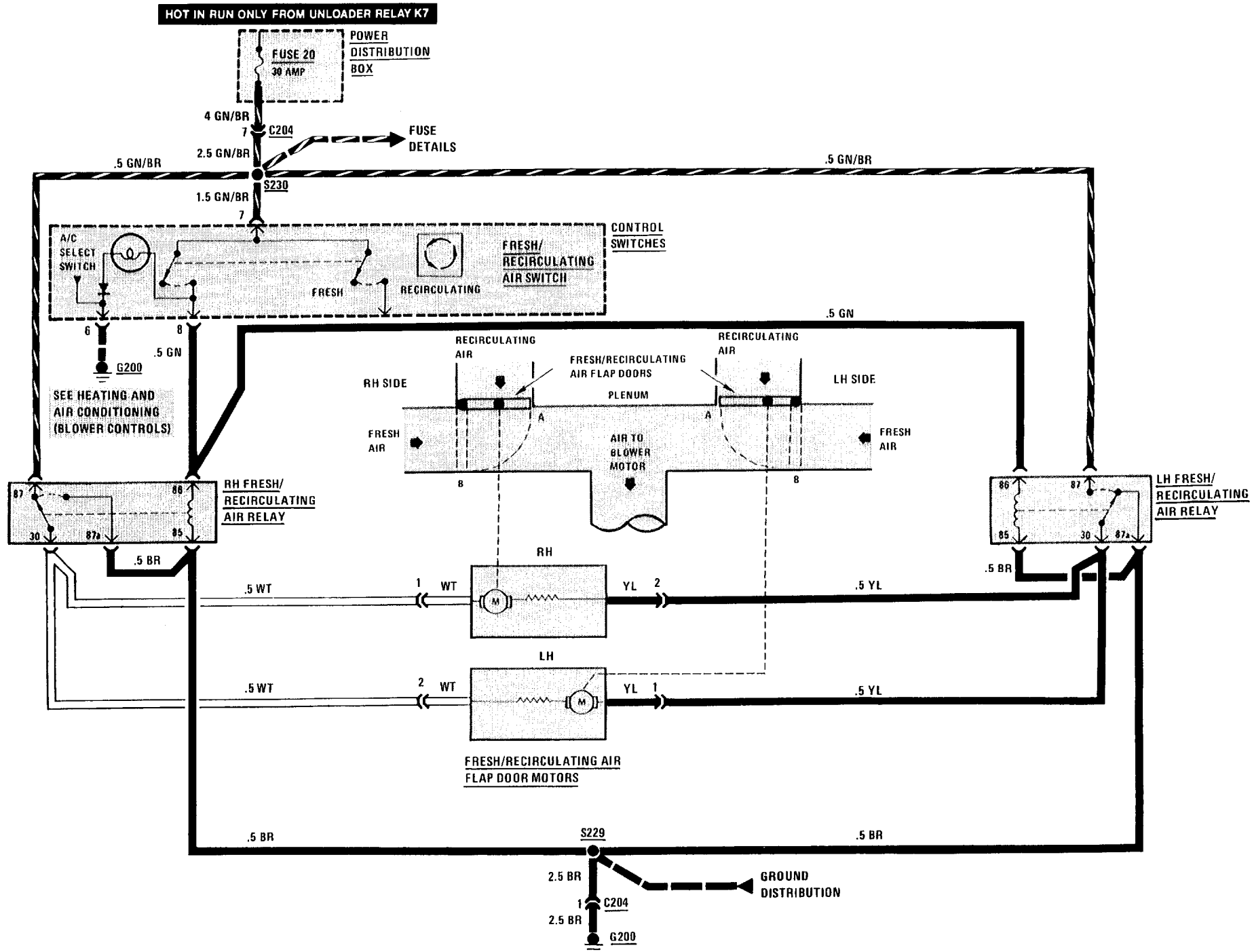

CIRCUIT OPERATION

When the Ignition Switch is in RUN, battery voltage is applied to terminal 7 of the Control Switches, the normally open contacts of the LH Fresh/Recirculating Air Relay, and the normally closed contacts of the RH Fresh/Recirculating Air Relay. If the Fresh/Recirculating Air Switch is not depressed (open), battery voltage is applied through the normally closed contacts of the RH Fresh/Recirculating Air Relay to both Fresh/Recirculating Air Flap Door Motors and then to ground through the normally closed contacts of the LH Fresh/Recirculating Air Relay. Both motors operate and move the Fresh/Recirculating Air Flap Doors to position A, allowing fresh air to enter the blower.

When the Fresh/Recirculating Air Switch is depressed (closed), battery voltage is applied through the switch to both the LH and RH Fresh/Recirculating Air Relay coils. Both relays are energized. Battery voltage is then applied through the closed contacts of the LH Fresh/Recirculating Air Relay to the Flap Door Motors, and to ground through the closed contacts of the RH Fresh/Recirculating Air Relay. Since the voltage is now applied to the Flap Door Motors in the opposite direction, the motors reverse direction and move the Fresh/Recirculating Air Flap Doors to position B, allowing only recirculating air to enter the blower. Both of the Air Flap Door Motors remain energized continuously. When the doors reach the end of their travel, the motors stall and hold the doors in position.

TROUBLESHOOTING HINTS

- Try the following checks before doing the System Diagnosis.
- 1. Check that LH and RH Fresh/Recirculating Air Relays are firmly seated.
- 2. Check that LH and RH Fresh/Recirculating Air Relay pigtail connectors are properly mated.
- Go to Heating and Air Conditioning (6410-0) System Check for a guide to normal operation.
- Go to System Diagnosis for diagnostic tests.

SYSTEM DIAGNOSIS

- Do the tests below if the Fresh/Recirculating Air Flap Doors do not operate.

A: FRESH/RECIRCULATING AIR FLAP DOOR MOTOR VOLTAGE TEST

Measure: VOLTAGE At: FRESH/RECIRCULATING AIR FLAP DOOR MOTOR PIGTAIL CONNECTORS (Disconnected) Conditions: <ul style="list-style-type: none"> • Ignition Switch: RUN • Fresh/Recirculating Air Switch: RELEASED (FRESH) 		
Measure Between	Correct Voltage	For Diagnosis
WT and Ground	Battery	See 1
WT and YL	Battery	See 2
• Fresh/Recirculating Air Switch: DEPRESSED (RECIRCULATING)		
YL and Ground	Battery	See 3

(Continued in next column)

(Continued from previous column)

YL and WT	Battery	See 3
• If all voltages are correct, replace the inoperative motor.		
1. Check the WT wire for an open. If wire is good, do Test B for RH Air Relay.		
2. Check the YL wire for an open. If wire is good, do Test B for LH Air Relay.		
3. Do Test B for both Air Relays.		

B: FRESH/RECIRCULATING AIR RELAY VOLTAGE TEST

Measure: VOLTAGE At: FRESH/RECIRCULATING AIR RELAY CONNECTOR (Disconnected) Conditions: <ul style="list-style-type: none"> • Ignition Switch: RUN • Fresh/Recirculating Air Switch: DEPRESSED (RECIRCULATING) • Fresh/Recirculating Air Flap Door Motor Connectors: CONNECTED 		
Measure Between	Correct Voltage	For Diagnosis
87 (GN/BR) and Ground	Battery	See 1
86 (GN) and Ground	Battery	See 2
86 (GN) and 85 (BR)	Battery	See 3
86 (GN) and 87a (BR)	Battery	See 3

(Continued on next page)

(Continued from previous page)

- If all voltages are correct, replace the suspect Fresh/Recirculating Air Relay.
- 1. Check the GN/BR wire for an open.
- 2. Check the GN wire back to the Control Switches for an open. If wire is good, do Test C.
- 3. Check the BR wire for an open.

C: CONTROL SWITCHES VOLTAGE TEST

Measure: VOLTAGE At: CONTROL SWITCHES CONNECTOR (Disconnected) Condition: • Ignition Switch: RUN		
Measure Between	Correct Voltage	For Diagnosis
7 (GN/BR) & Ground	Battery	See 1
7 (GN/BR) & 8 (GN)	Battery	See 2
<ul style="list-style-type: none"> • If both voltages are correct, replace the Control Switches. 1. Check the GN/BR wire for an open. If wire is good, check that connector C204 is properly mated. 2. Check the GN wire for an open between the Control Switches and the LH and RH Fresh/Recirculating Air Relays. 		

6452-0 A/C COMPRESSOR CONTROLS

HEATING AND AIR CONDITIONING (COMPRESSOR CONTROLS)

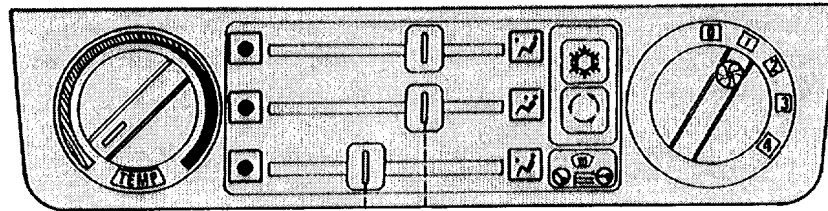

HOT IN RUN ONLY FROM UNLOADER RELAY K7

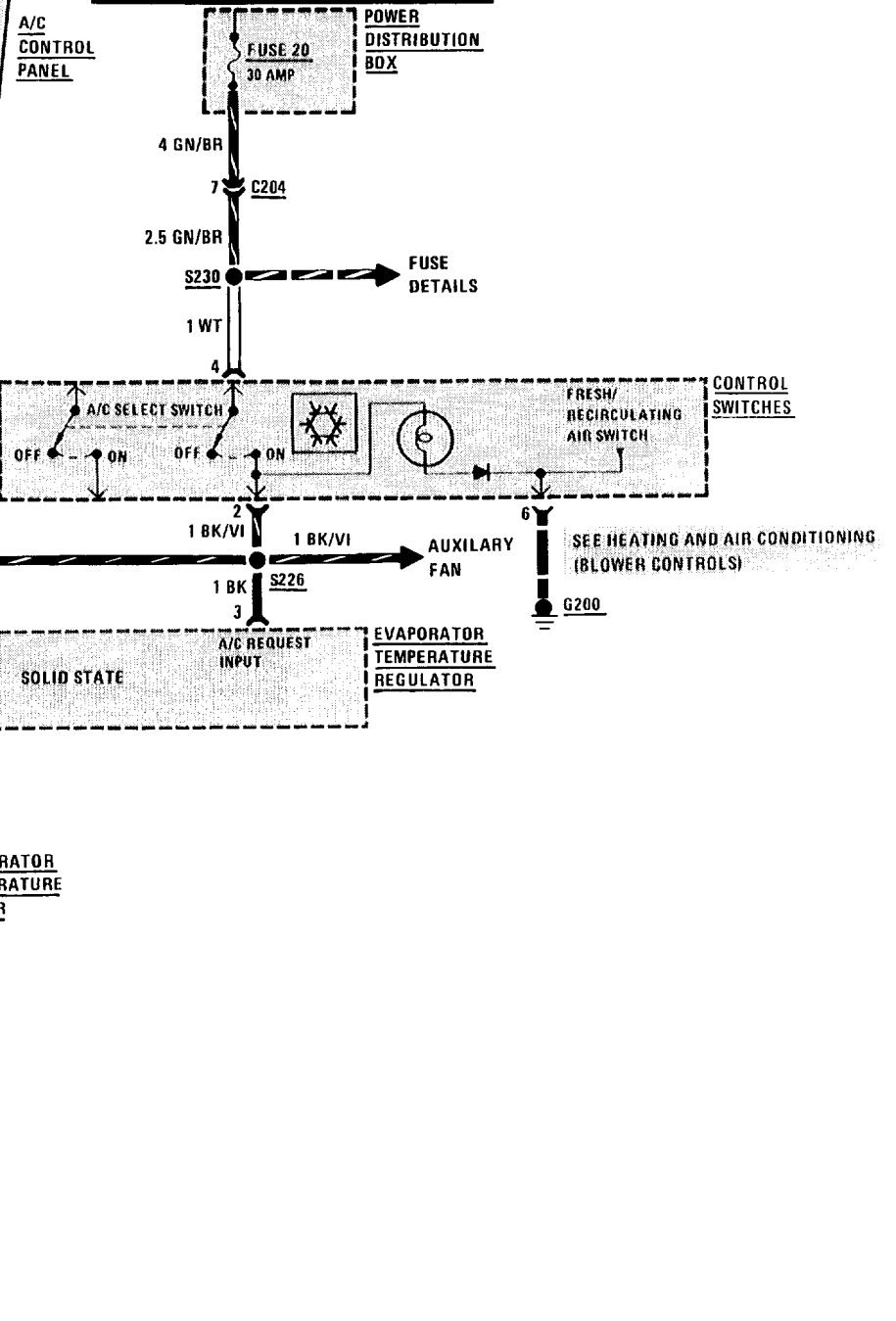

HEATING AND AIR CONDITIONING (COMPRESSOR CONTROLS)

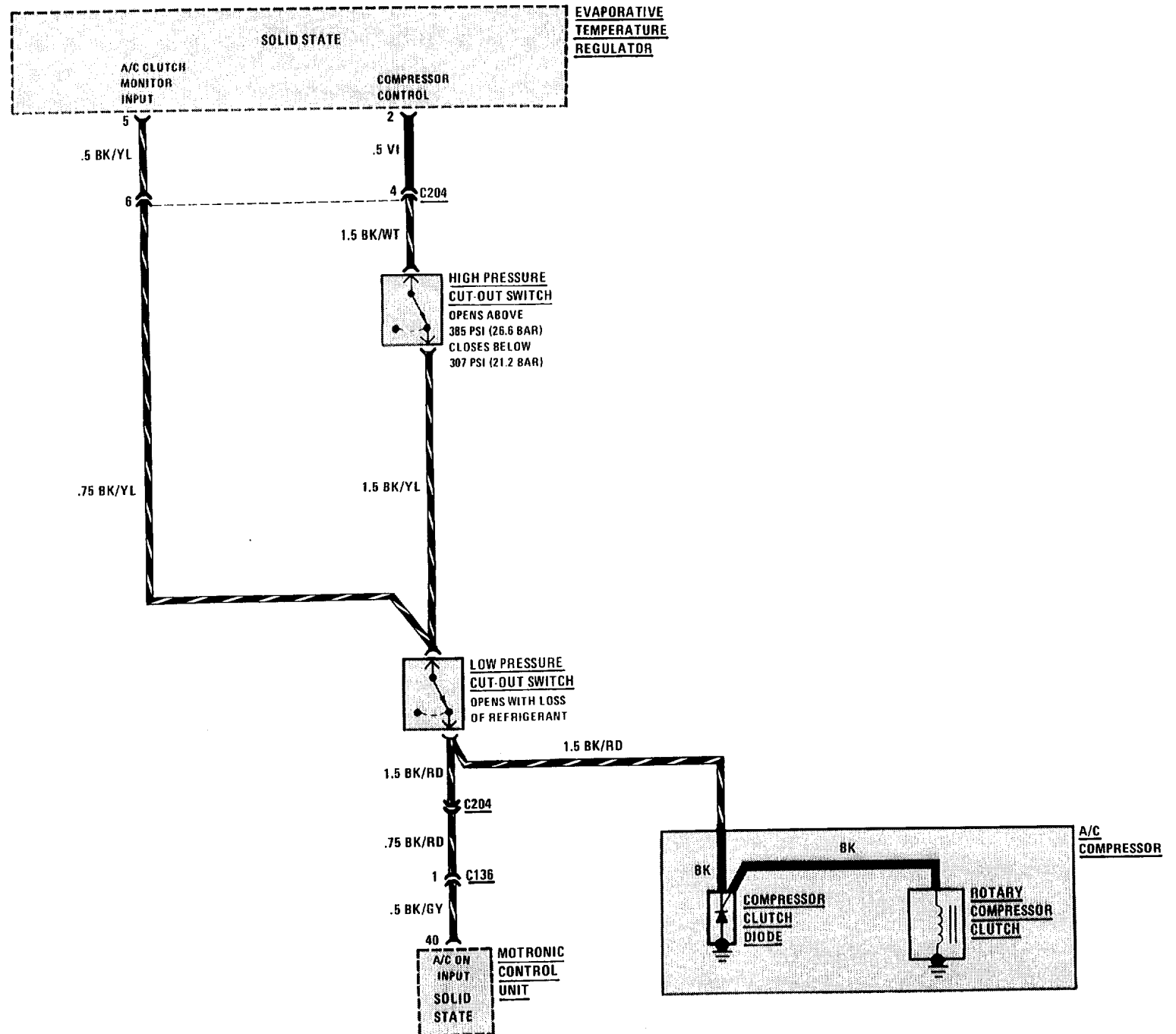

CIRCUIT OPERATION

When the Ignition Switch is in RUN, battery voltage is applied through Fuse 20 to the A/C Select Switch. When the A/C Select Switch is pressed voltage is applied to terminal 3 of the Evaporator Temperature Regulator. The Evaporator Temperature Regulator applies voltage from terminal 2 to the Compressor Clutch through the High Pressure Cut-Out Switch, the Low Pressure Cut-Out Switch, and the Temperature Switch.

The High Pressure Cut-Out Switch will disengage the Compressor Clutch when refrigerant pressure rises above 385 PSI (26.6 Bar). The Evaporator Temperature Regulator will detect the High Pressure Cut-Out Switch opening at terminal 5 and will turn off the output voltage at the Compressor Control terminal. The Evaporator Temperature Regulator will not allow the Compressor Clutch to be turned on again until circuit continuity has been restored between terminals 5 and 2. The Evaporator Temperature Regulator tests for continuity by momentarily applying voltage at the Compressor Control every 8 to 10 seconds. Voltage at the A/C Clutch Monitor Input indicates continuity. The Evaporator Temperature Regulator will continue to apply voltage at the Compressor Control output, which will energize the Compressor Clutch.

The Temperature Switch opens to remove the compressor load from the engine if the engine coolant temperature rises above 226°F (108°C). The Evaporator Temperature Sensor signals the Evaporator Temperature Regulator to de-energize the Compressor Clutch when evaporator temperature is low enough for freezing to result.

Clutch Diode

Whenever the Compressor Clutch is de-energized, the collapsing magnetic field induces a voltage in the winding. The Clutch Diode provides a path for the resulting current.

A/C On Input

When the Compressor Clutch is turned on, voltage is applied to terminal 29 of the Motronic Control Unit. The Motronic Control Unit uses this signal increase idle speed to compensate for the increased engine load from the Compressor Clutch engaging.

TROUBLESHOOTING HINTS

- Try the following checks before doing the System Diagnosis.
 1. Check Fuse 20 by visual inspection.
 2. Check that Compressor Clutch connector is firmly seated.
- Go to Heating and Air Conditioning (6410A-0) System Check for a guide to normal operation.
- Go to System Diagnosis for diagnostic tests.

SYSTEM DIAGNOSIS

- Do the tests listed for your symptom in the Symptom Table below.
- Tests follow the Symptom Table.

SYMPTOM TABLE

Compressor Clutch does not engage	A
Engine idle speed is not high enough when Compressor Clutch engages (325 engine only)	D

A: A/C ISOLATION TEST (TABLE 1)

Measure: VOLTAGE At: EVAPORATOR TEMPERATURE REGULATOR (Disconnected) Conditions: <ul style="list-style-type: none"> • Ignition Switch: RUN (Engine need not be running) • A/C Selector Switch: ON (Depressed) 		
Measure Between	Correct Voltage	For Diagnosis
3 & Ground	Battery	See 1
<ul style="list-style-type: none"> • If voltage is correct, go to Table 2. 1. Go to Test E. 		

A: A/C ISOLATION TEST (TABLE 2)

Connect: FUSED JUMPER At: EVAPORATOR TEMPERATURE REGULATOR (Disconnected) Conditions: • Ignition Switch: RUN • A/C Selector Switch: ON (Depressed)		
Connect Across	Correct Result	For Diagnosis
2 & 3	Compressor Clutch Engages	See 1
• If result is correct go to Test C. 1. Go to Test B.		

B: PRESSURE SWITCH TEST

Measure: RESISTANCE At: EVAPORATOR TEMPERATURE REGULATOR CONNECTOR (Disconnected) Conditions: • Ignition Switch: OFF • Negative Battery Terminal: DISCONNECTED		
Measure Between	Correct Resistance	For Diagnosis
2 & Ground	Approximately 3 to 4 ohms	See 1
• If measurement is correct replace the Evaporator Temperature Regulator. 1. Check for an open Low Pressure Cut-Out Switch, High Pressure Cut-Out Switch, A/C Temperature Switch, or associated wiring (see schematic). If High Pressure Cut-Out Switch is open, check refrigerant pressure to be sure it is normal before replacing the switch. Replace the A/C Temperature Switch if it is open and engine coolant temperature is below 226 °C (108 °C). If the switches and related wiring is OK, replace the Compressor Clutch.		

C: EVAPORATOR TEMPERATURE REGULATOR VOLTAGE AND RESISTANCE TEST

Measure: RESISTANCE At: EVAPORATOR TEMPERATURE REGULATOR CONNECTOR (Disconnected) Conditions: • Ignition Switch: OFF • Negative Battery Terminal: DISCONNECTED		
Measure Between	Correct Resistance	For Diagnosis
1 & Ground	Approximately 3.5K to 4.5K ohms at 70 °F (21 °C)	See 1
4 & Ground	Less than 0.5 ohms	See 2
6 & Ground	Less than 0.5 ohms	See 2
5 & 2	Less than 0.5 ohms	See 3
• If all resistances are correct but Compressor Clutch does not operate normally, replace the Evaporator Temperature Regulator. 1. Check the BK/WT wire for an open or a short to ground (see schematic). Check the BR wire for an open (see schematic). If wires are good, replace the Evaporator Temperature Sensor. 2. Check the BR wire for an open (see schematic). 3. Check BK/YL for an open between terminal 5 and the Low Pressure Cut-Out Switch.		

D: IDLE SPEED CONTROL VOLTAGE TEST

Measure: VOLTAGE At: MOTRONIC CONTROL UNIT CONNECTOR (Connected – Universal Adapter) Conditions: <ul style="list-style-type: none"> • Ignition Switch: RUN • A/C Control Panel: A/C ON • Temperature Outside Car: Above 60 degrees F (16 degrees C) 		
Measure Between	Correct Voltage	For Diagnosis
40 (BK/GY) & Ground	Battery	See 1
41 (VI/GY) & Ground	Battery	See 2
<ul style="list-style-type: none"> • If the voltage is correct, repair/replace the Motronic Control Unit. <ol style="list-style-type: none"> 1. Check for an open in the BL/WT and BK/RD wires. 2. Check for an open in the VI/GY and BK/VI wires. 		

E: A/C SELECT SWITCH VOLTAGE TEST

Measure: VOLTAGE At: CONTROL SWITCHES CONNECTOR (Connected) Conditions: <ul style="list-style-type: none"> • Ignition Switch: RUN • A/C Control Panel: A/C ON • Temperature Outside Car: Above 60 degrees F (16 degrees C) 		
Measure Between	Correct Voltage	For Diagnosis
4 (WT) & Ground	Battery	See 1
2 (BK/VI) & Ground	Battery	See 2
<ul style="list-style-type: none"> • If both voltages are correct, check connections at Evaporator Temperature Regulator. <ol style="list-style-type: none"> 1. Check for an open in the WT and GN/BR wires. 2. Replace the A/C Select Switch. 		

6454-0 AUXILIARY FAN

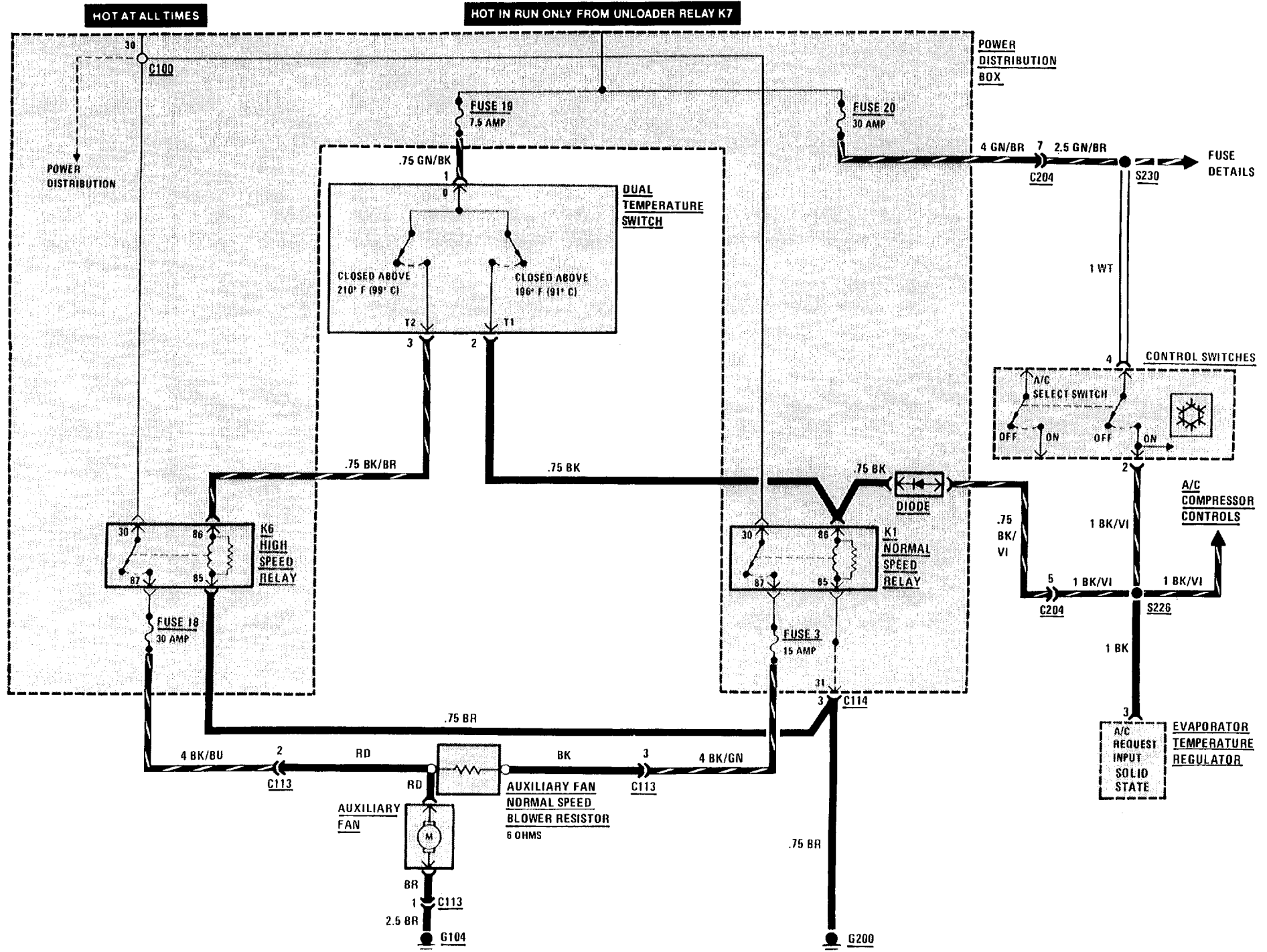

6500-0 RADIO/ANTENNA

WITH SOUND SYSTEM

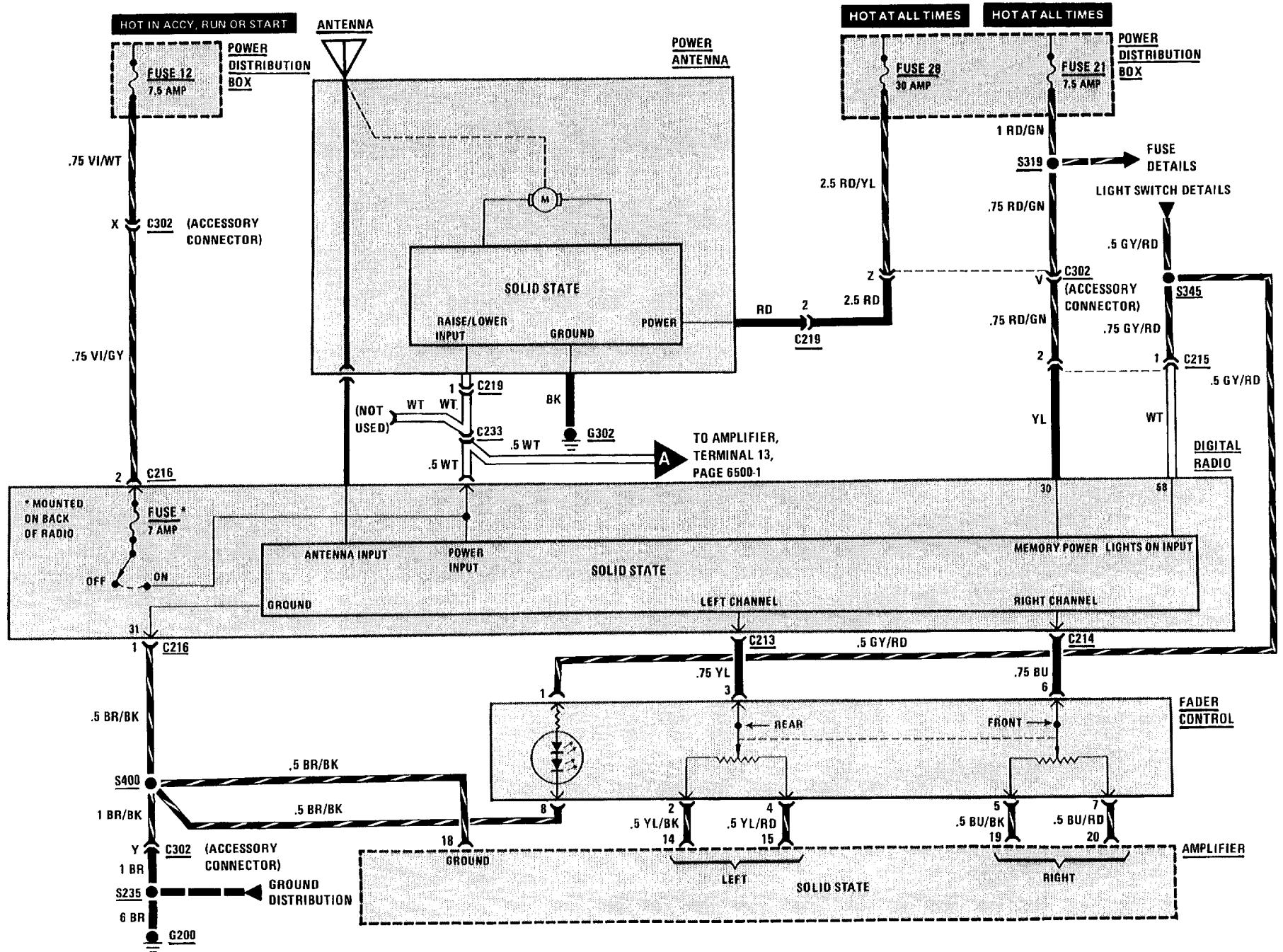

WITH SOUND SYSTEM

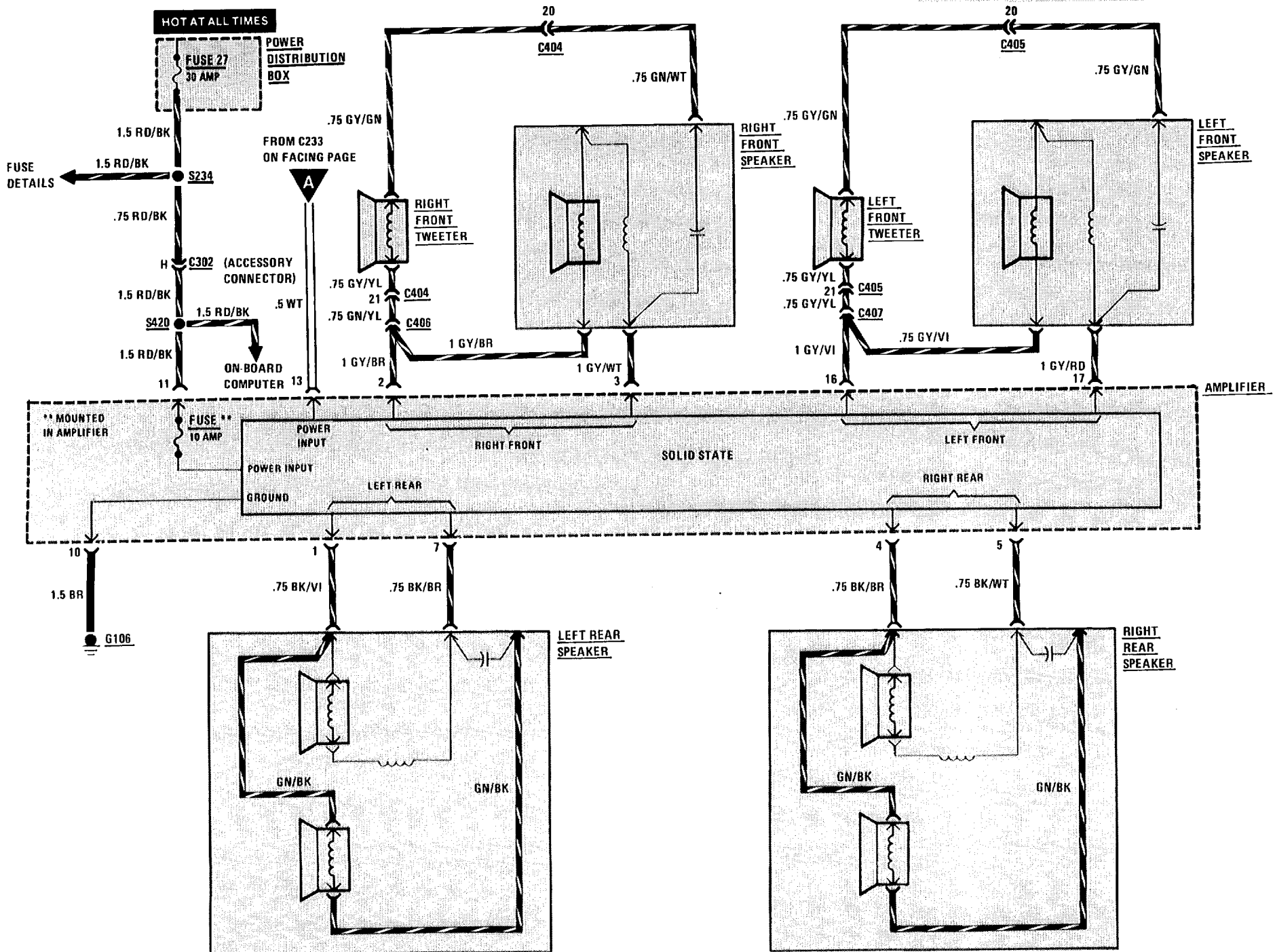

CIRCUIT OPERATION

With the Ignition Switch in ACCY, RUN or START, Fuse 12 provides voltage to turn on the three components in the system. When the Radio Switch is on, voltage is applied to the Radio, the Power Antenna Raise/Lower Input, and the Amplifier. This voltage is used to control the individual unit's main power supply.

When the Raise/Lower Input of the Power Antenna receives voltage, power is supplied from Fuse 28 to run the motor and raise the Antenna. When voltage is no longer present at the Raise/Lower Input, the Antenna is lowered.

Fuse 21 constantly supplies voltage to the Memory Power Input of the Radio. This allows the Radio to maintain the present settings while it is turned off.

The Amplifier receives constant power at terminal 11 from Fuse 28. When the Radio is on, voltage is applied to terminal 13 to enable the Amplifier.

The actual Radio signal originates at the Antenna. It is supplied to the Radio, processed, and output from the Left Channel and Right Channel Outputs to the Fader Control. The Fader Control alters the front to rear volume by decreasing the resistance to the desired higher volume outputs. The signal is then input to the Left Front, Left Rear, Right Front, and Right Rear Inputs to the Amplifier. After amplification, the signal is output to the corresponding speakers.

TROUBLESHOOTING HINTS

- Try the following checks before doing the System Check.
 1. Check power input to the Radio by observing if Instrument Cluster Indicators light.
 2. Check power input to Antenna by observing the Cigar Lighter.
 3. Check memory power to Radio by checking operation of the Glove Box Light.
 4. Check power input to the Amplifier.
 5. If Fader Control has no effect, but sound is heard from all speakers, replace the Fader Control.
 6. Check that the Antenna is properly connected.
 7. Before troubleshooting a suspect Speaker, check all connections to that Speaker.
 8. If display shows "CODE" and Radio will not operate, the individual Anti-Theft Code must be entered. Refer to "Anti-Theft" instruction booklet.
 9. Check Radio Fuse located on back of Radio.
 10. Check Amplifier Fuse located on back of Amplifier.
- Go to System Check for a guide to normal operation.
- Go to System Diagnosis for diagnostic tests.

SYSTEM CHECK

- Use the System Check Table as a guide to normal operation.
- Refer to System Diagnosis for a list of symptoms and diagnostic steps.

SYSTEM CHECK TABLE

ACTION	NORMAL RESULT
With Ignition Switch in RUN, turn Radio ON.	Antenna extends. Digital display lights. Sound is emitted from all Speakers.
Operate Fader Control.	Sound volume varies from front to rear.

- Refer to System Diagnosis when a result is not normal.

SYSTEM DIAGNOSIS

- Do the tests listed for your symptom in the Symptom Table below.
- Tests follow the Symptom Table.

SYMPTOM TABLE

SYMPTOM	FOR DIAGNOSIS
Radio does not work (no display, no sound).	Do Test A
Digital display lights, but there is no sound.	Do Test B
LH Speakers or RH Speakers do not operate.	Do Test C

(Continued on next page)

(Continued from previous page)

Antenna does not extend or retract.	Check ground wire for an open. Make sure ground G302 is clean and tight. Check wire to Power Antenna for opens. If OK, replace Power Antenna.
An individual Speaker does not operate.	Do Test D
Excessive noise comes from all Speakers.	Do Test E

A: RADIO POWER TEST

Measure: VOLTAGE At: RADIO CONNECTOR C216 (Disconnected) or CONNECTOR C215 (Disconnected) Condition: • Ignition Switch: RUN		
Measure Between	Correct Voltage	For Diagnosis
C216 Ground	Battery	See 1
C216/2 & C216/1	Battery	See 2
C215/2 & Ground	Battery	See 3
• If all voltages are correct, check wire from connector C215 to Radio for an open. If wire is OK, remove Radio for service. 1. Check power input wire for an open. 2. Check ground wire for an open to ground. Make sure ground G200 is clean and tight. 3. Check memory power supply wire for an open.		

B: AMPLIFIER POWER TEST

Measure: VOLTAGE At: AMPLIFIER CONNECTOR (Disconnected) Conditions: • Ignition Switch: RUN • Radio: ON		
Measure Between	Correct Voltage	For Diagnosis
11 & Ground	Battery	See 1
11 & 18	Battery	See 2
13 & Ground	Battery	See 3
11 & 10	Battery	See 4
• If all voltages are correct, go to Test C. 1. Check power supply wire for an open. 2. Check Amplifier ground to Amplifier for an open to ground. Make sure ground G200 is clean and tight. 3. Check Amplifier "Radio On" wire for an open. 4. Check wire from terminal 10 for an open to ground. Make sure ground G302 is clean and tight.		

C: FADER SIGNAL TEST (TABLE 1)

Measure: VOLTAGE At: FADER CONTROL CONNECTOR (Disconnected) Conditions: • Ignition Switch: RUN • Radio: ON		
Measure Between	Correct Voltage	For Diagnosis
3 & Ground	Approximately 6 Volts	See 1
6 & Ground	Approximately 6 Volts	See 2
• If both voltages are correct, check for AC voltage at Radio outputs with Radio tuned to a strong signal. If AC voltage is present, go to Table 2. Remove Radio for service if AC voltage is not present. 1. Check wire from Left Channel on Radio for an open. If wire is good, remove Radio for service. 2. Check wire from Right Channel on Radio for an open. If wire is good, remove Radio for service.		

(Continued on next page)

6500A-2 RADIO/ANTENNA

(Continued from previous page)

C: FADER SIGNAL TEST (TABLE 2)

Measure: VOLTAGE At: AMPLIFIER CONNECTOR (Disconnected) Conditions: • Ignition Switch: RUN • Radio: ON		
Measure Between	Correct Voltage	For Diagnosis
14 & Ground	Approximately 6 Volts	See 1
15 & Ground	Approximately 6 Volts	See 2
19 & Ground	Approximately 6 Volts	See 3
20 & Ground	Approximately 6 Volts	See 4

• If all voltages are correct but sound was not present, remove Amplifier for service.

1. Check between pin 2 (Fader) to pin 14 (Amplifier) for an open in the wiring. If wire is OK, replace Fader Control.
2. Check between pin 4 (Fader) to pin 15 (Amplifier) for an open in the wiring. If wire is OK, replace Fader Control.
3. Check between pin 5 (Fader) to pin 19 (Amplifier) for an open in the wiring. If wire is OK, replace Fader Control.
4. Check between pin 7 (Fader) to pin 20 (Amplifier) for an open in the wiring. If wire is OK, replace Fader Control.

D: SUSPECT SPEAKER TEST

Connect: OHMMETER At: SUSPECT SPEAKER (Disconnected) Condition: • Ohmmeter set on Rx 1 scale or Diode Check Scale		
Action	Correct Result	For Diagnosis
Connect Ohmmeter across Speaker Terminals	Speaker "pops"	See 1

• If the result is correct, check wires to the Amplifier for opens or shorts. If wires are OK, check the related wire between Fader and Amplifier.

1. Replace the suspect Speaker.

E: NOISE DIAGNOSIS

With Radio on and noise present, unplug the Antenna at the back of the Radio.

- If noise is no longer present, it was being picked up by the Antenna. Perform Antenna Noise Test.
- If noise persists, it is coming in the Radio wiring. Refer to the following Noise Symptom Table.

ANTENNA NOISE TEST

Measure: RESISTANCE At: ANTENNA		
Measure Between	Correct Resistance	For Diagnosis
Antenna Plug Base & Ground	Less than 3 Ohms	See 1
Antenna Plug Tip & Antenna Plug Base	Greater than 1 Megaohm (open circuit)	See 2

• If both resistances are correct, check the hood ground strap. If hood ground strap is OK, substitute a different Antenna at Radio. If the new Antenna is good, replace Antenna. If noise is still present, refer to Noise Symptom Table.

1. Check ground contact at Antenna base. If necessary, install a braided ground strap from the Antenna Base to Chassis ground. Check for an open in the Antenna Cable.
2. Check for a short to ground at the Antenna or Antenna cable.

NOISE SYMPTOM TABLE

SYMPTOM	POSSIBLE CAUSE	REPAIR ACTION
Harsh popping or crackling noise present when ignition on-changes with engine rpm.	Ignition Noise	<ul style="list-style-type: none"> • Check for proper distributor cap shielding. • Check shielding ground strap. If not present, install. • Check for defective spark plug or spark plug wire. • Reroute spark plug wires laying against anything that could be transmitting noise to the Radio (wiring or sensor leads traveling into the passenger compartment). • Check engine/firewall ground strap and engine hood/body ground strap. • Check if engine hood is closing properly. • Connect dedicated ground strap to Radio. • Replace distributor cap and rotor.
High whine or howling that changes with engine rpm.	Alternator noise	<ul style="list-style-type: none"> • Connect dedicated ground strap to Radio. • Run a direct wire from Battery to Alternator.
AM only is weak and noisy.	AM alignment	<ul style="list-style-type: none"> • Remove Radio for service.
FM only is weak and noisy.	FM alignment	<ul style="list-style-type: none"> • Remove Radio for service.

6581-0 ON-BOARD COMPUTER

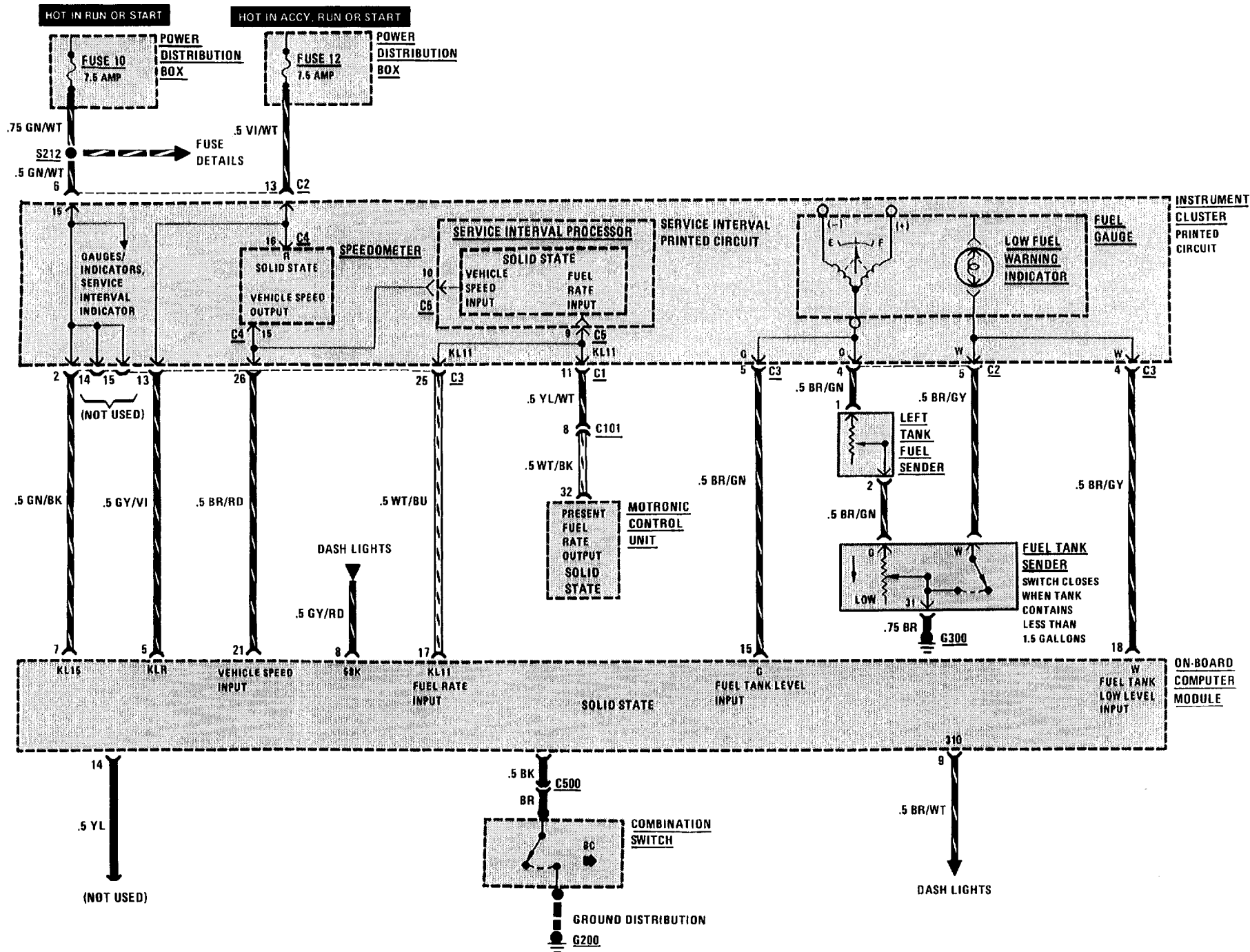

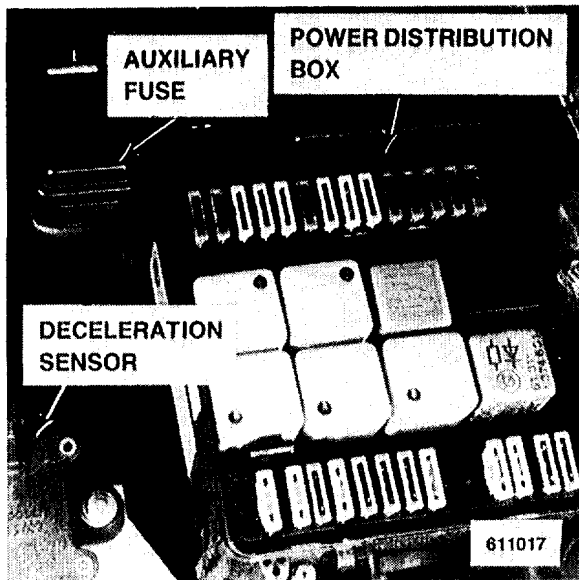

Figure 1 - LH Rear of Engine Compartment

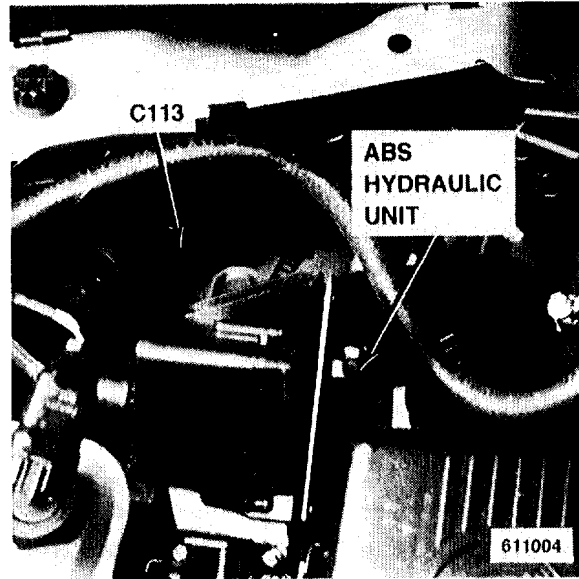

Figure 3 - LH Front of Engine Compartment

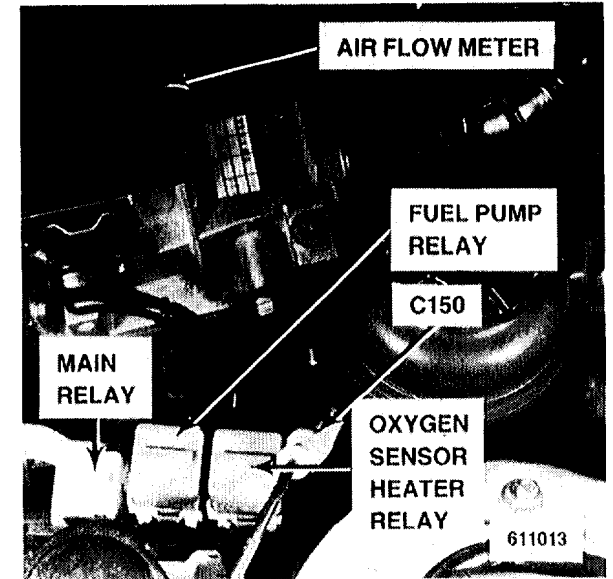

Figure 5 - Forward of LH Front Shock Tower (Relay Cover Removal)

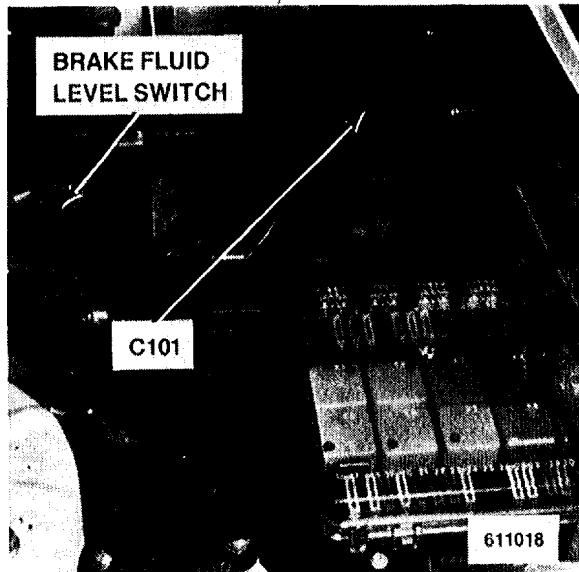

Figure 2 - LH Rear of Engine Compartment



Figure 4 - Lower LH Side of Engine

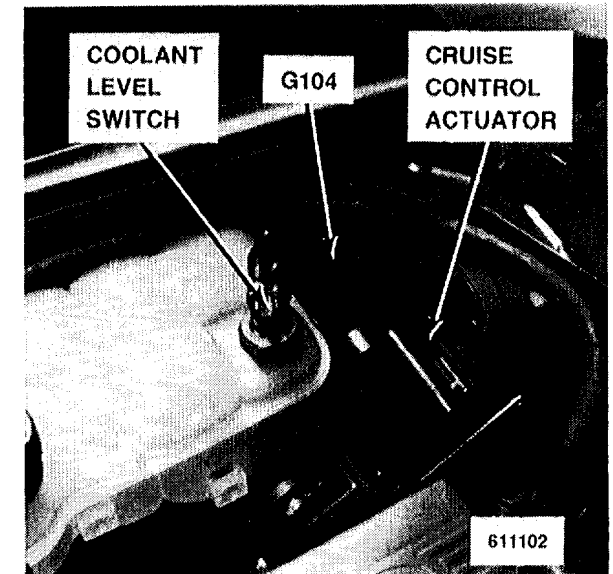

Figure 6 - Forward of LH Front Wheel Well

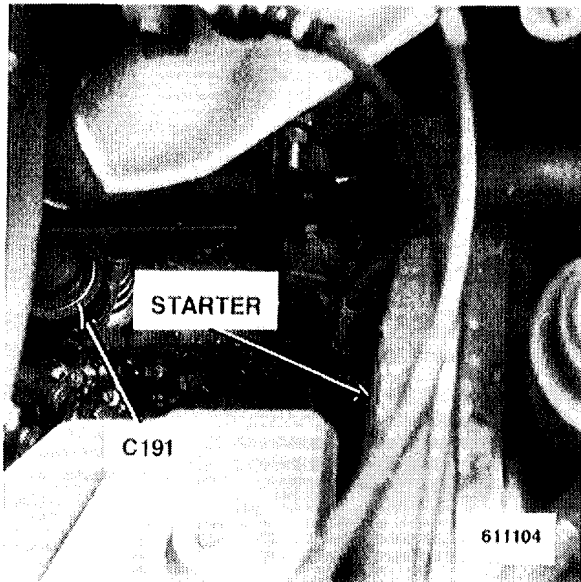

Figure 1 - Lower LH Rear of Engine

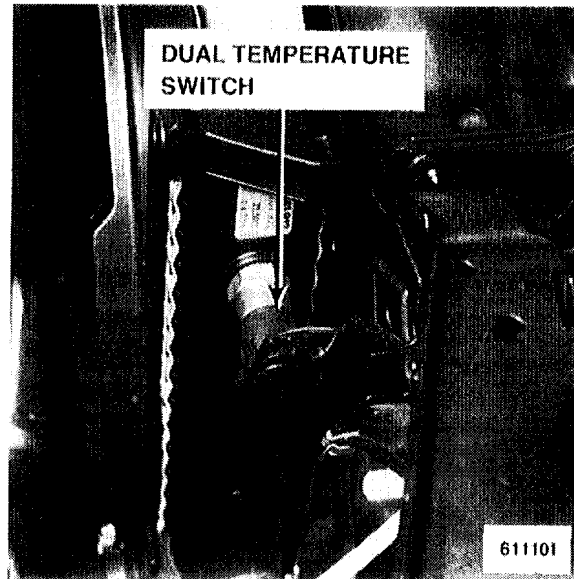

Figure 3 - Top RH Side of Radiator

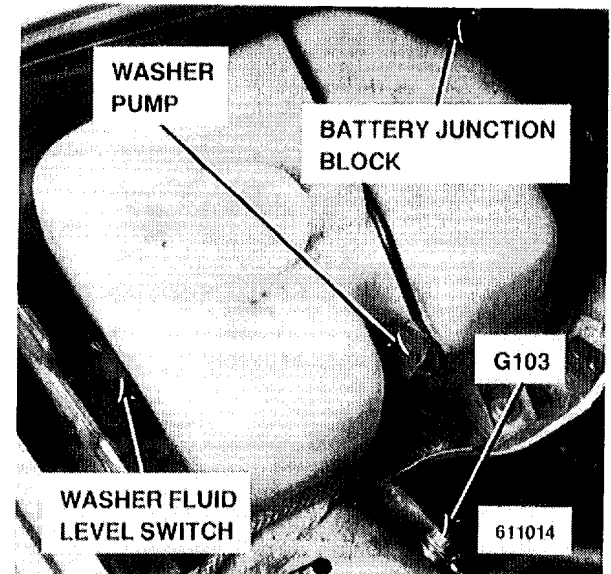

Figure 5 - RH Rear of Engine Compartment

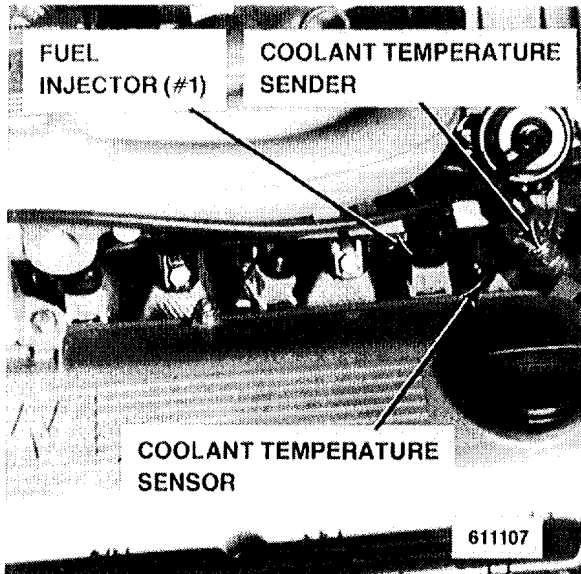

Figure 2 - Top Front of Engine

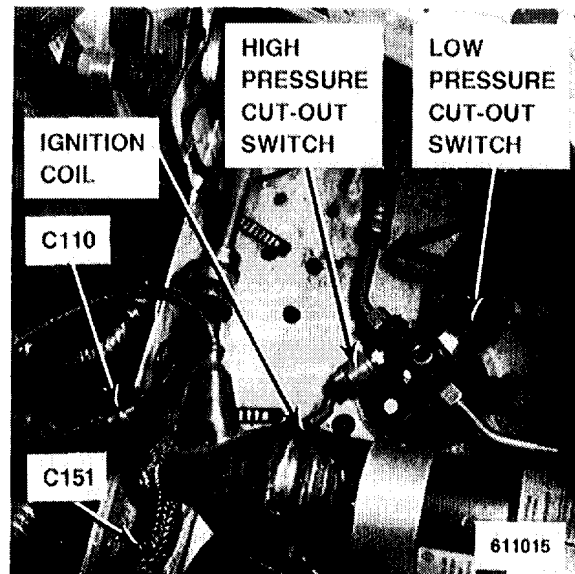

Figure 4 - Behind RH Headlights (Cover Removed)

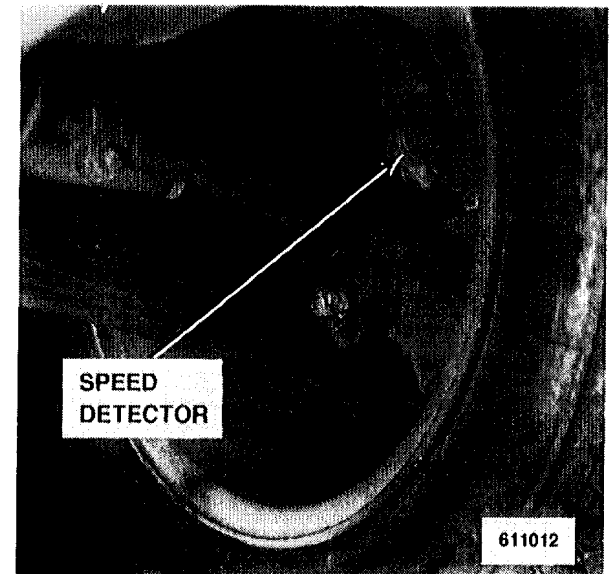

Figure 6 - Behind LH Front Wheel

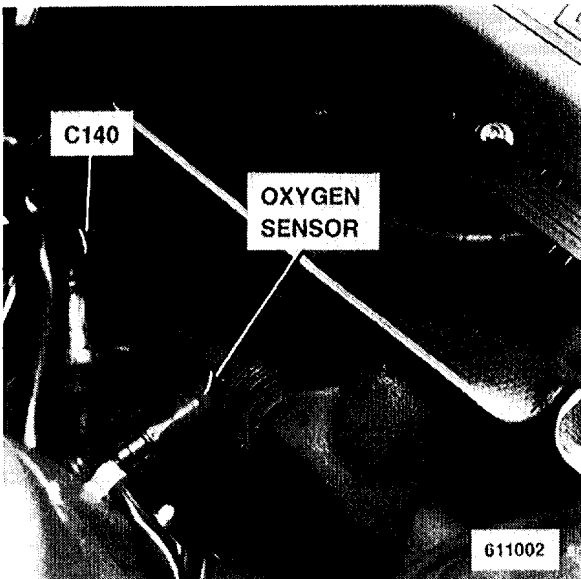

Figure 1 - Lower RH Rear of Engine Compartment

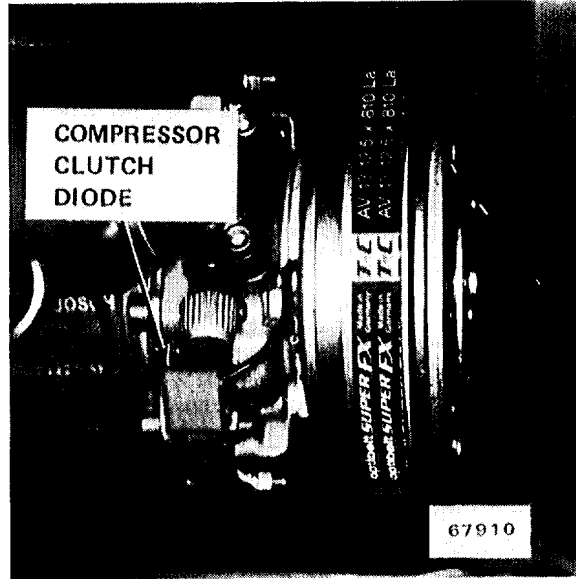

Figure 3 - Lower RH Front of Engine

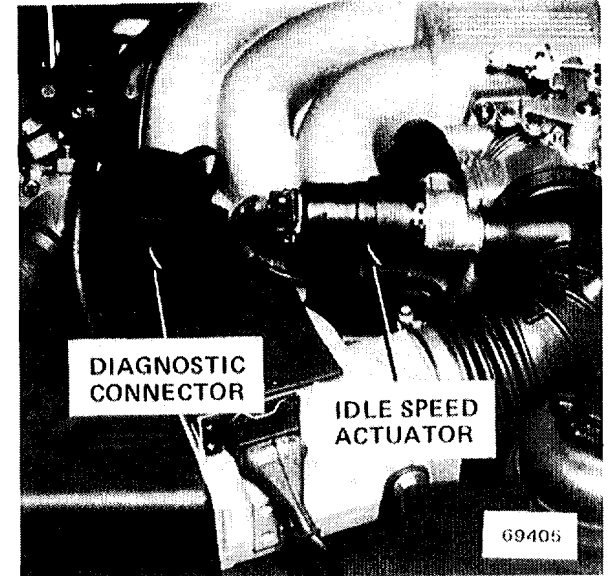

Figure 5 - LH Front of Engine

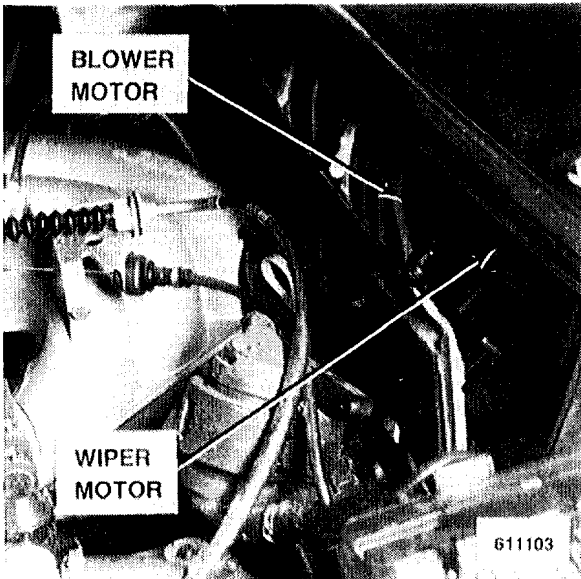

Figure 2 - Behind Cowl

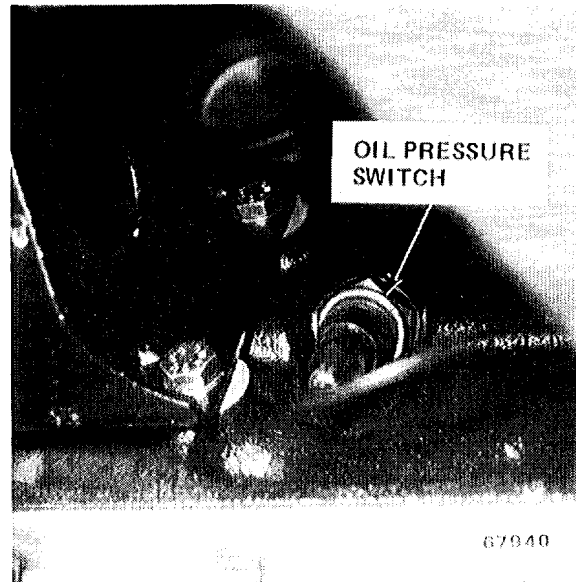

Figure 4 - Lower RH Front of Engine

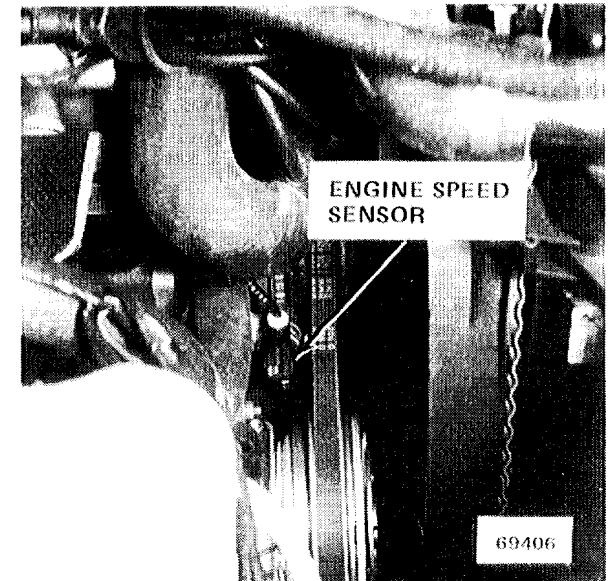

Figure 6 - Lower RH Front of Engine

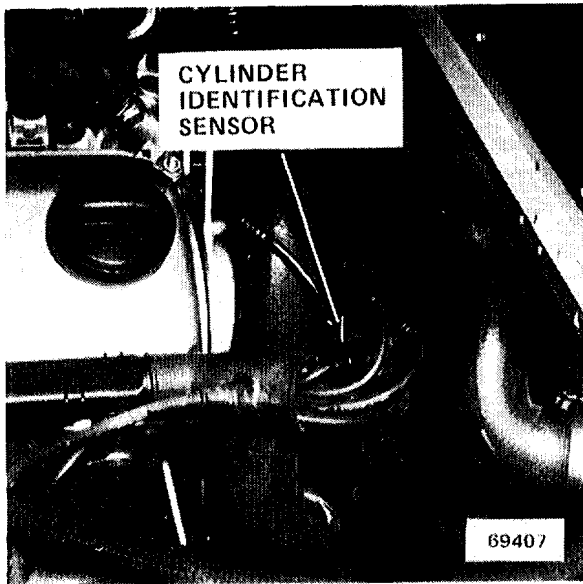

Figure 1 - RH Front of Engine
(Cover Removed)

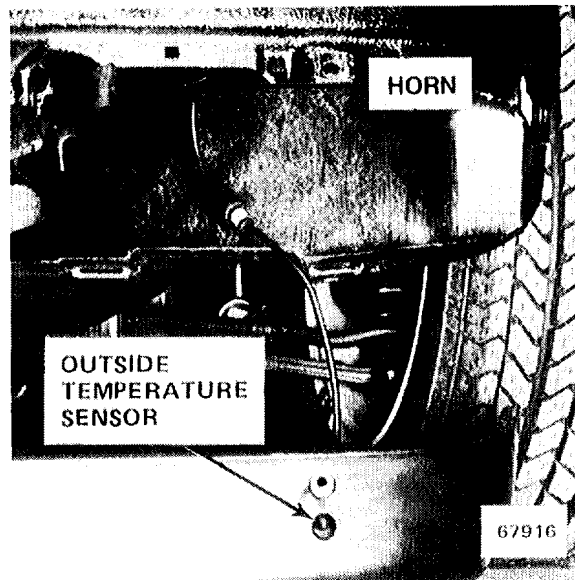

Figure 3 - Under LH Side of Front Bumper
(Splash Guard Pulled Down)

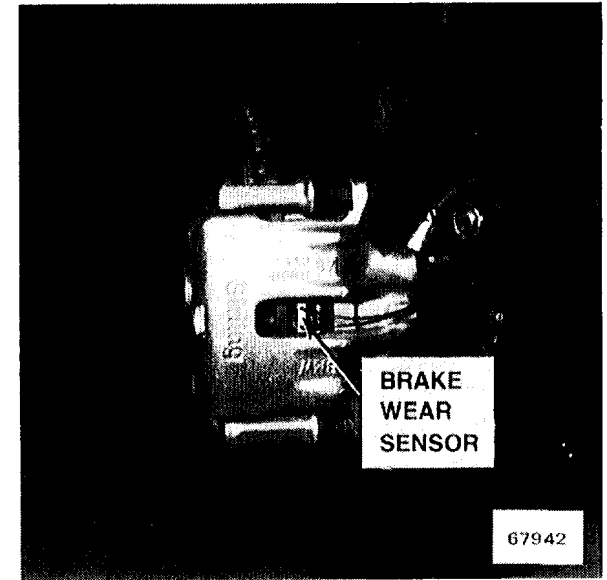

Figure 5 - LH Front Brake Assembly
(Wheel Removed)

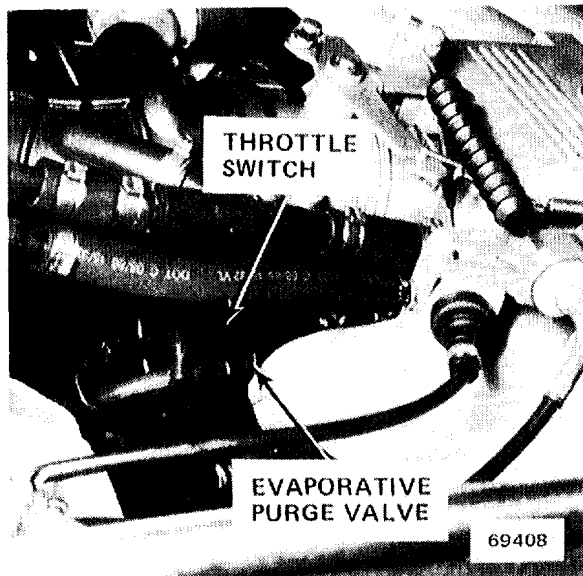

Figure 2 - LH Side of Engine

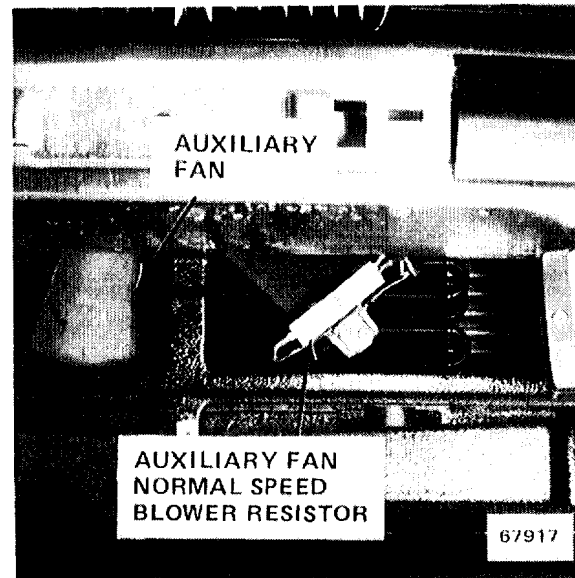

Figure 4 - Under Middle of Front Bumper

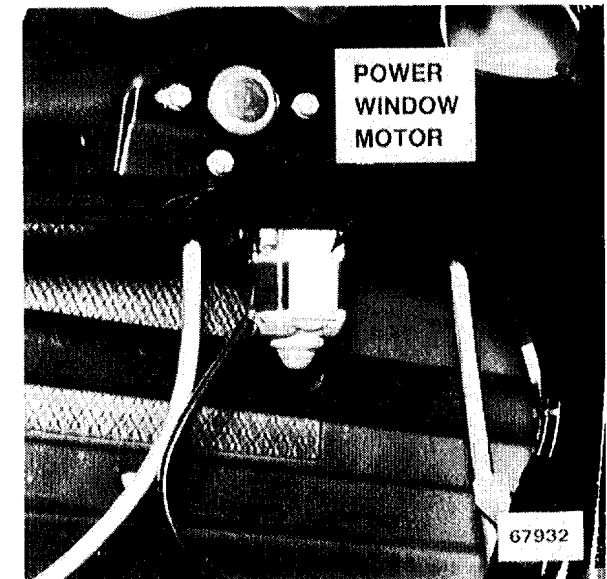

Figure 6 - Inside LH Front Door
(Panel Removed)

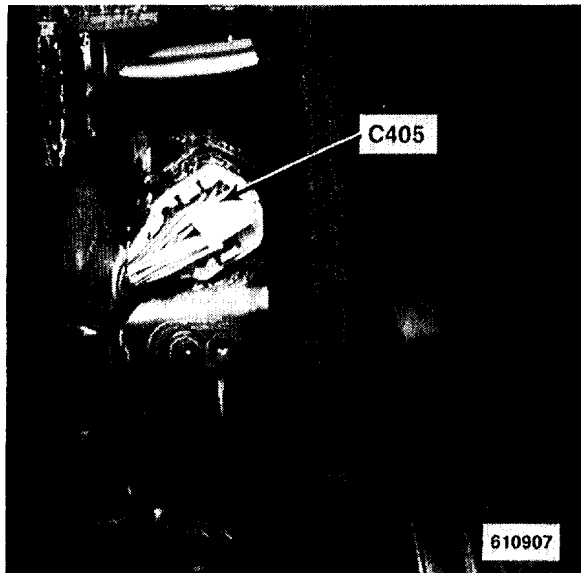

Figure 1 - Above LH Front Door Jamb Switch

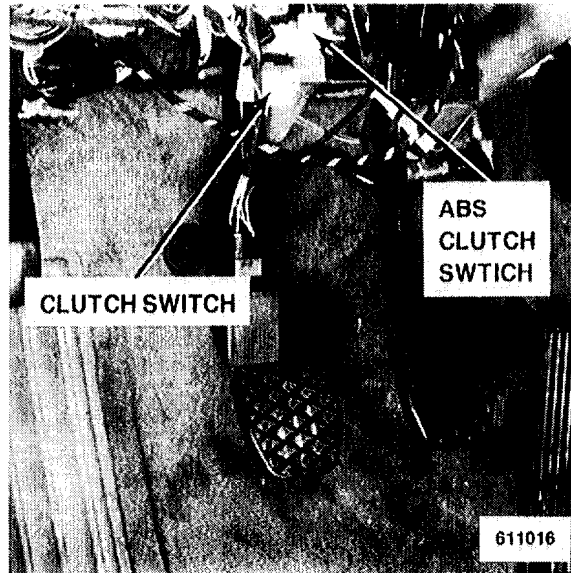

Figure 3 - Under LH Side of Dash

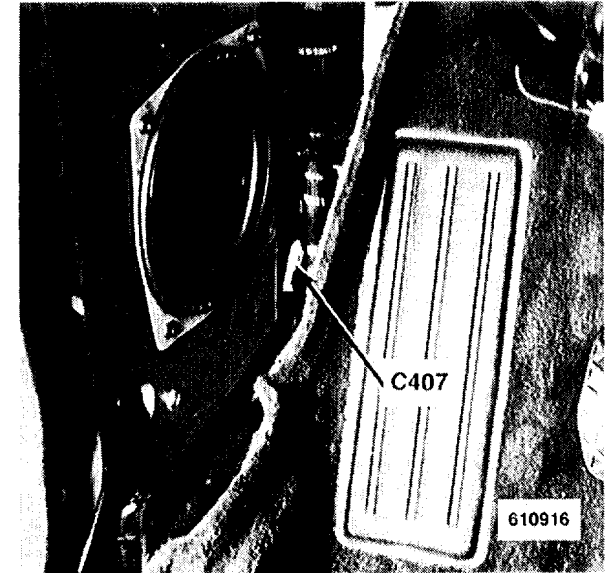

Figure 5 - Below LH Front Speaker

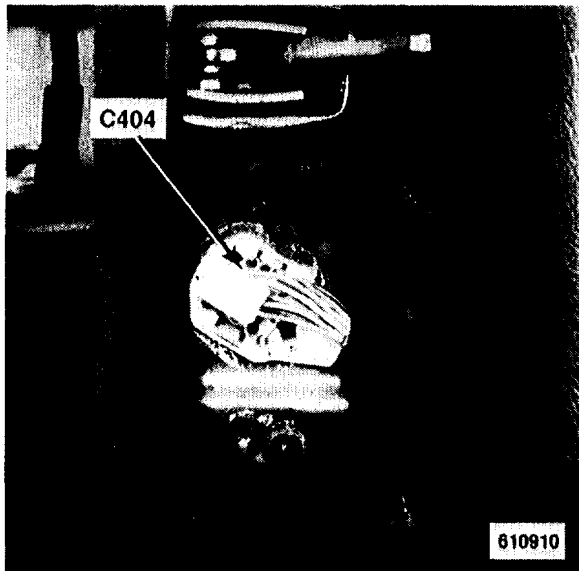

Figure 2 - Above RH Front Door Jamb Switch

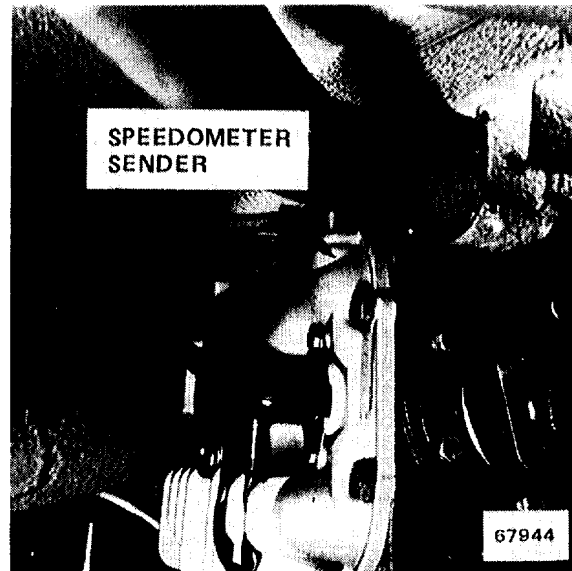

Figure 4 - RH Rear of Differential

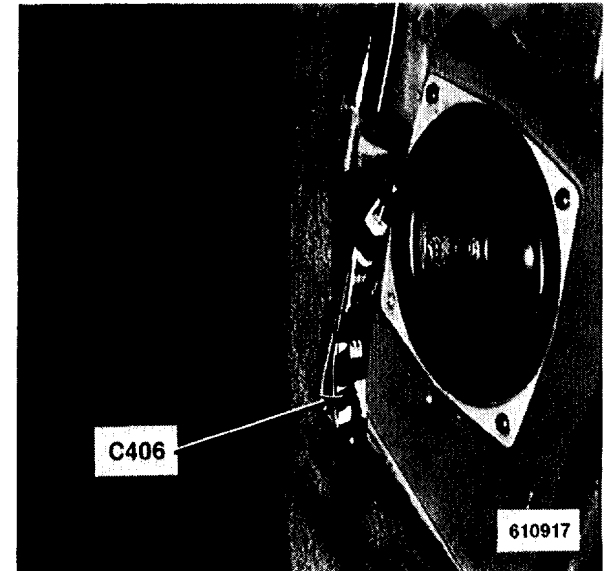

Figure 6 - Below RH Front Speaker

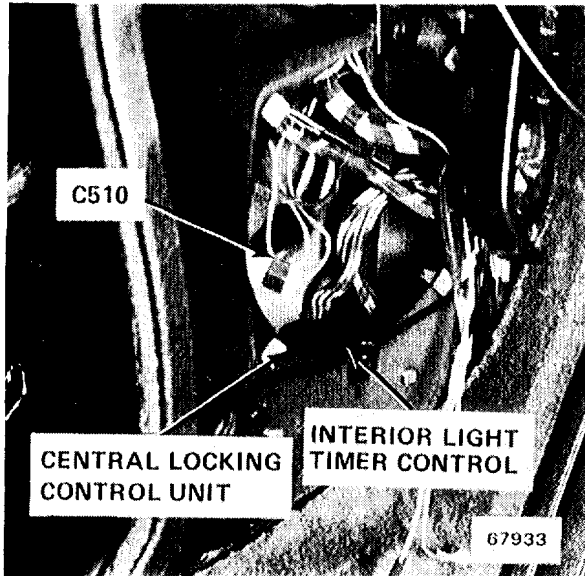

Figure 1 - Behind LH Front Speaker

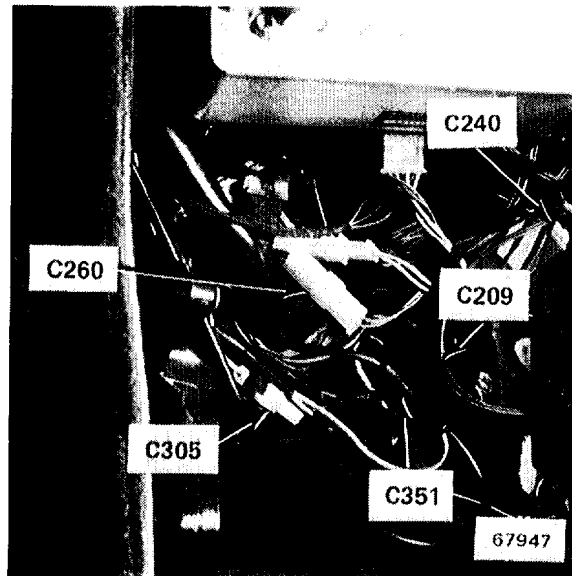

Figure 3 - Under LH Side of Dash

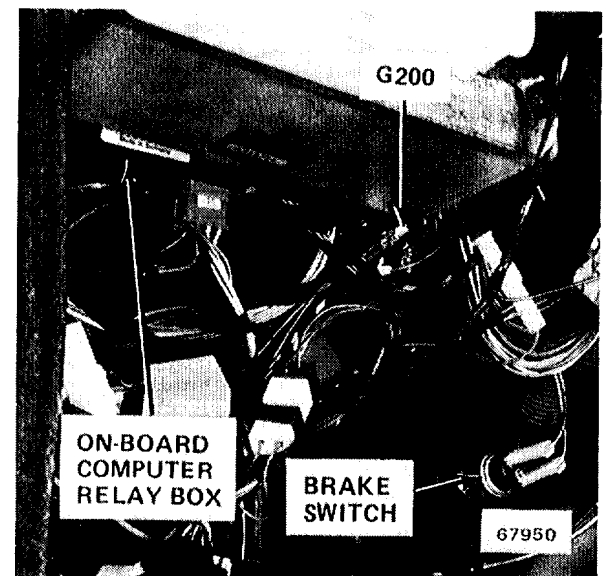

Figure 5 - Under LH Side of Dash

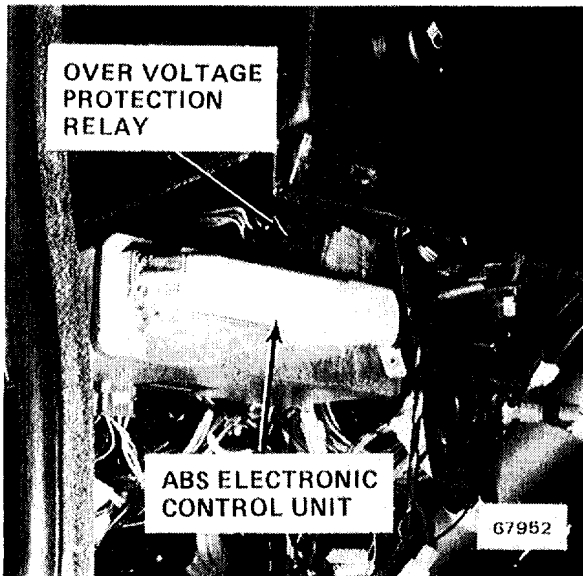

Figure 2 - Under LH Side of Dash

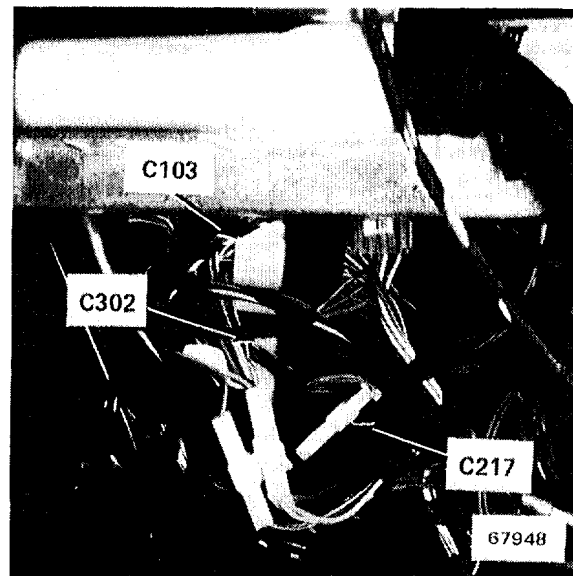

Figure 4 - Under LH Side of Dash

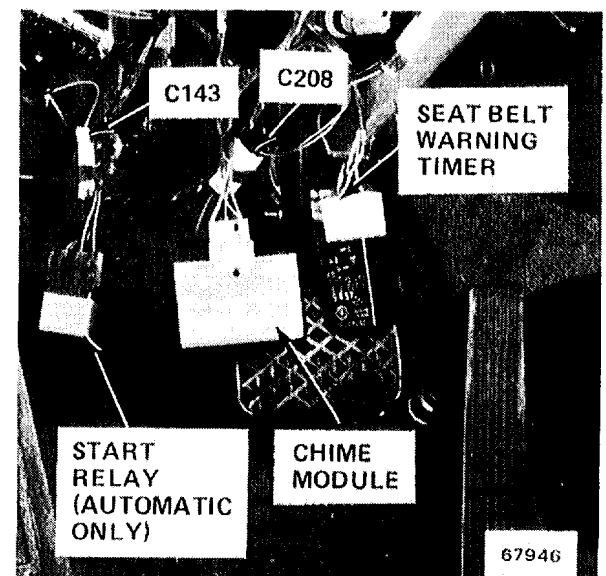

Figure 6 - Under LH Side of Dash



Figure 1 - Under LH Side of Dash

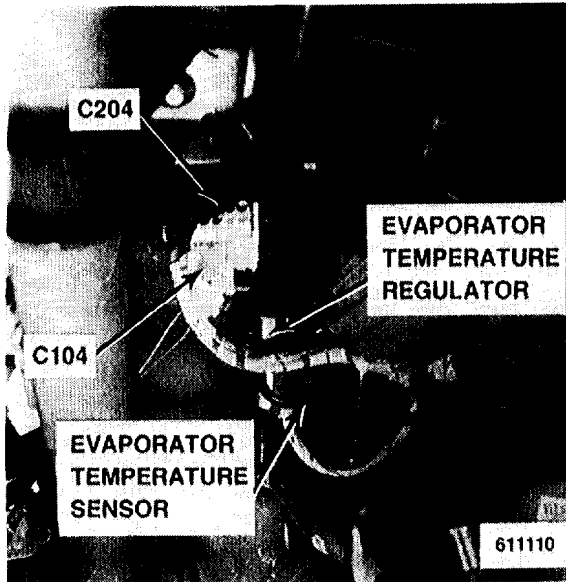

Figure 3 - Under LH Side of Dash

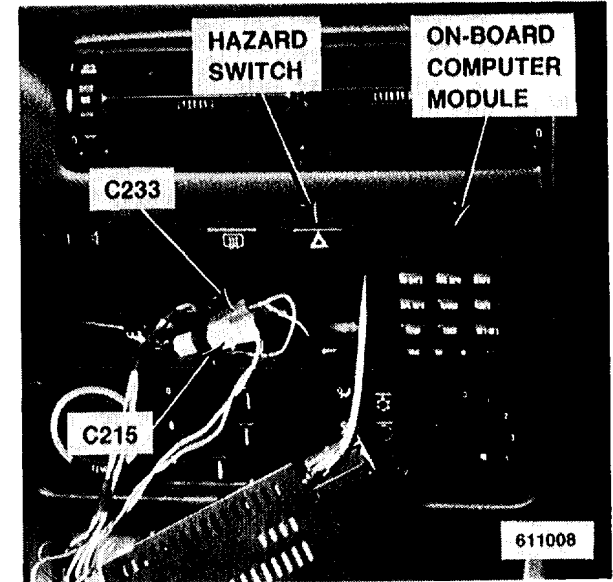

Figure 5 - Center of Dash

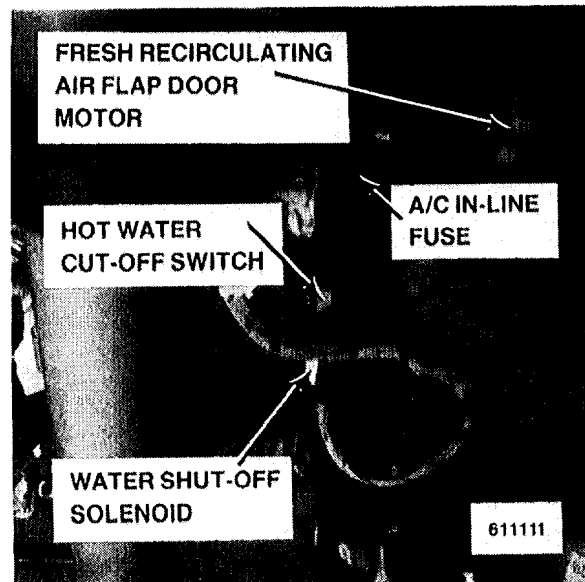

Figure 2 - Under LH Side of Dash

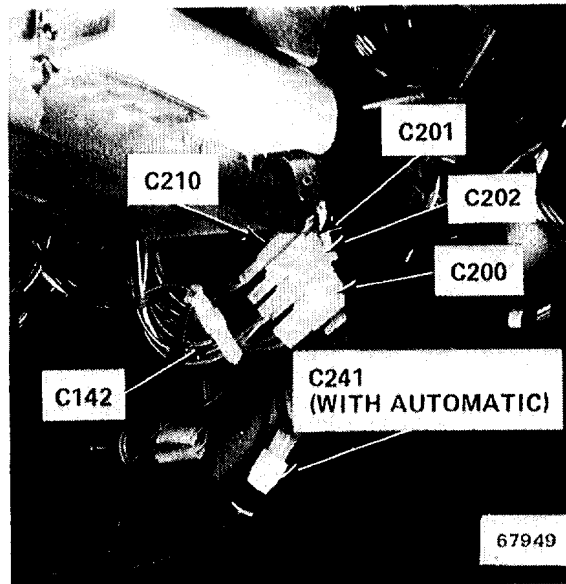

Figure 4 - Top of Steering Column

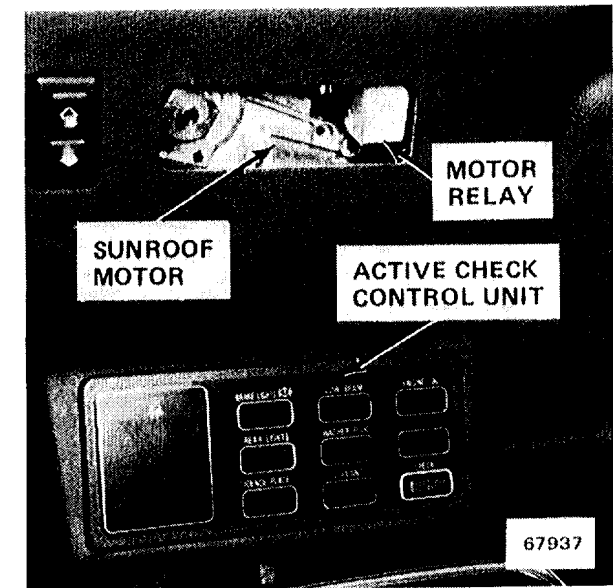

Figure 6 - Center of Windshield Header

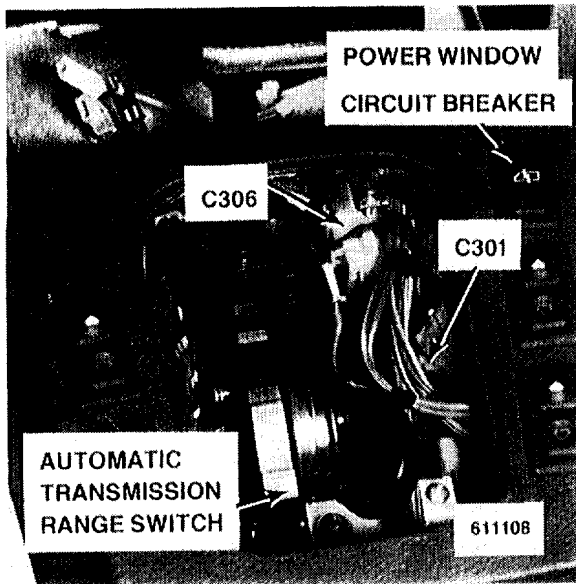

Figure 1 - Center Console

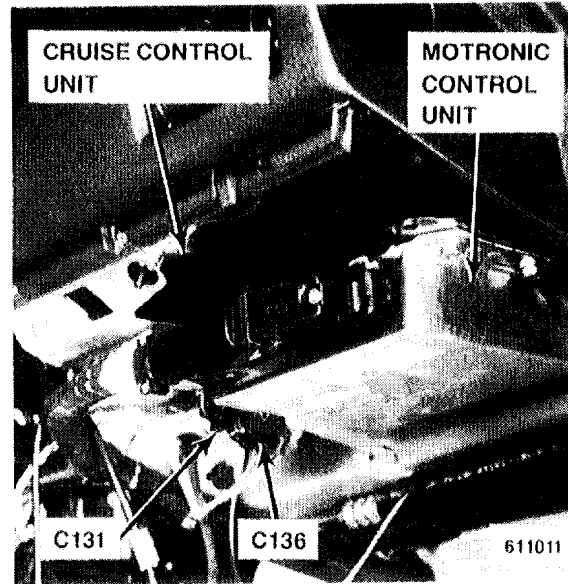

Figure 3 - Under RH Side of Dash

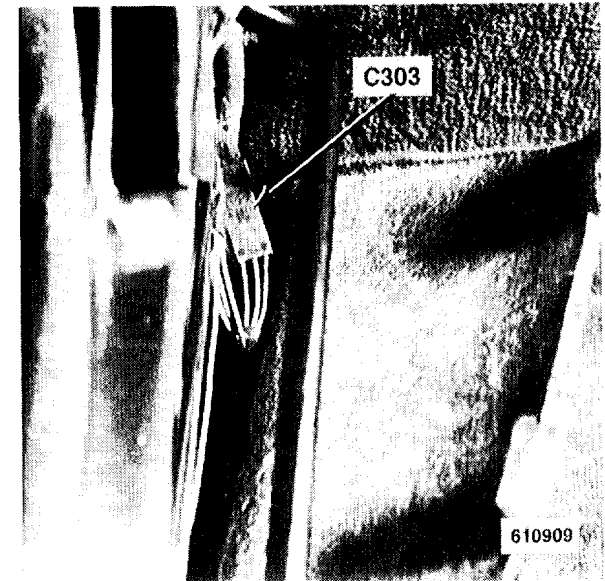

Figure 5 - At Base of RH "B" Pillar

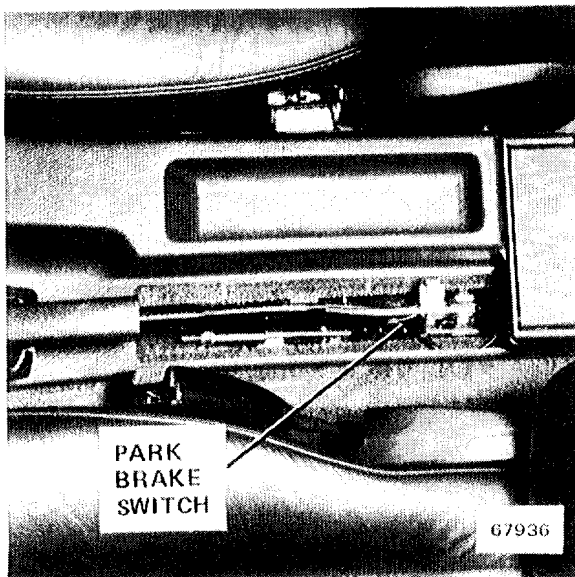

Figure 2 - Rear of Center Console

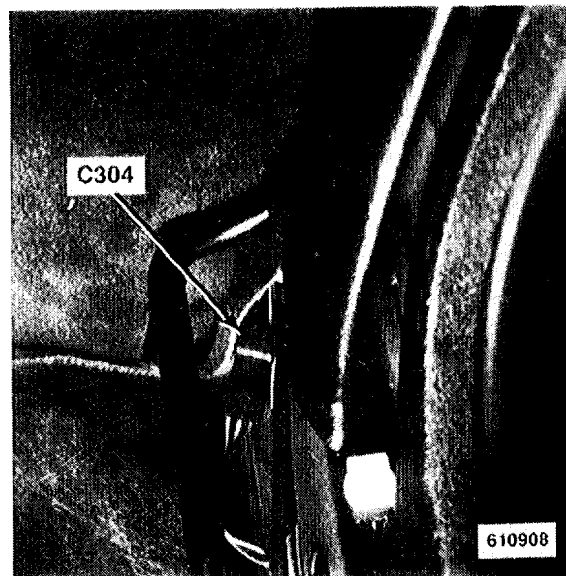

Figure 4 - At Base of LH "B" Pillar

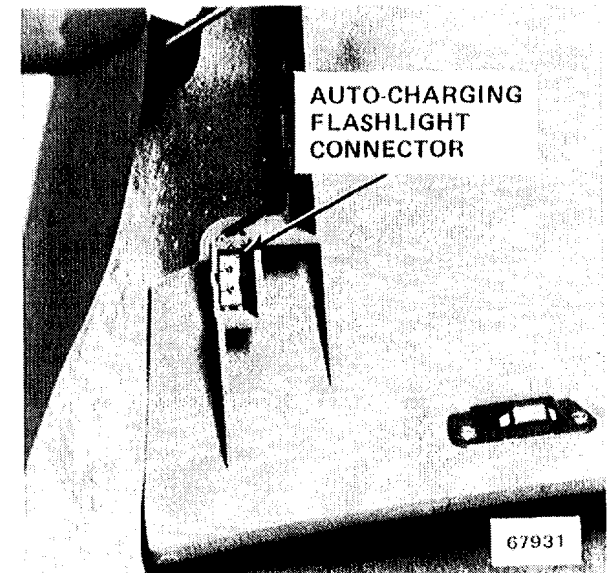

Figure 6 - Inside Glove Box

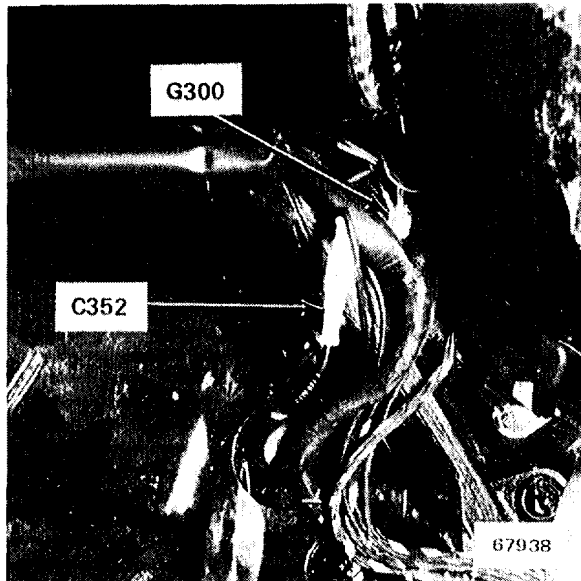

Figure 1 - Under LH Side of Rear Seat

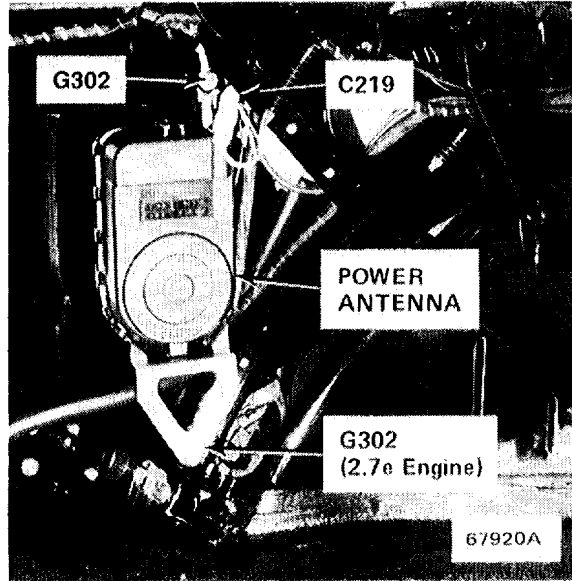

Figure 3 - LH Front of Trunk



Figure 5 - Middle Rear of Trunk

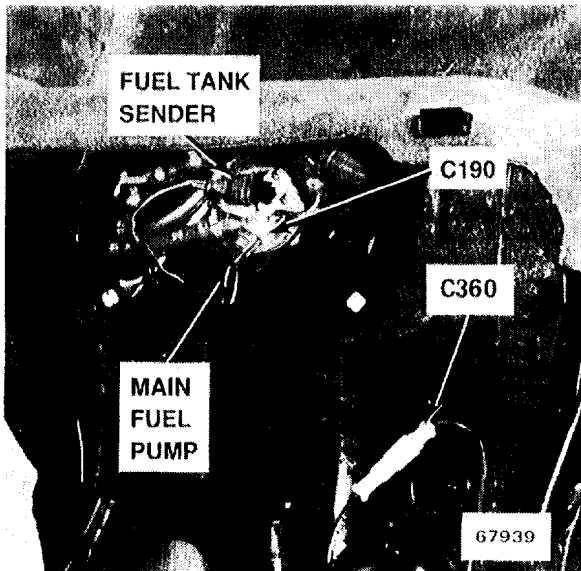

Figure 2 - Under RH Side of Rear Seat

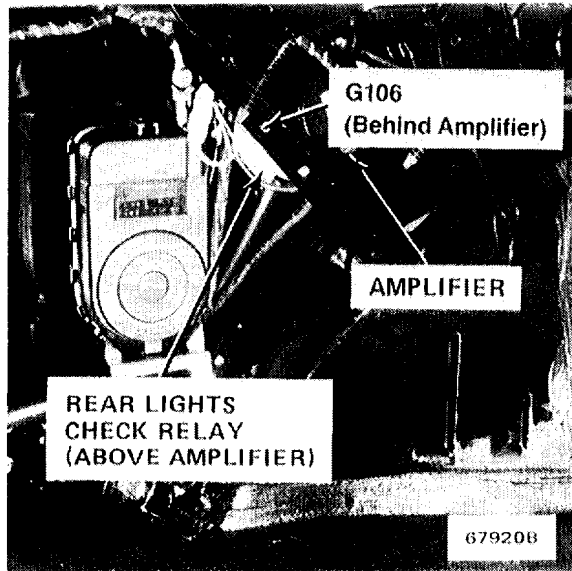

Figure 4 - LH Front of Trunk

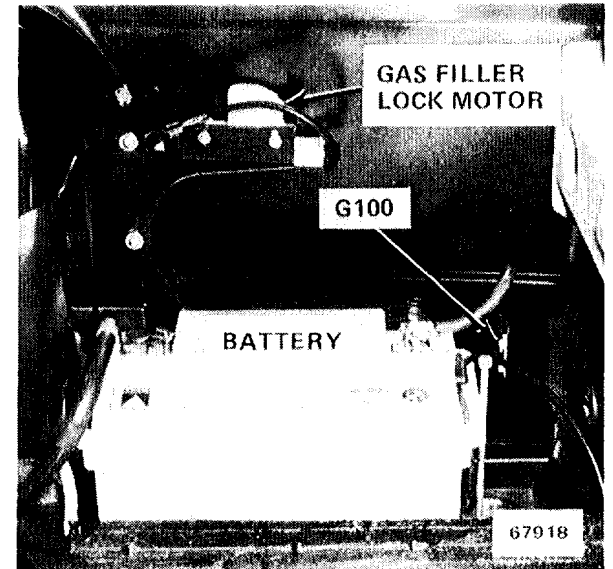

Figure 6 - RH Rear of Trunk

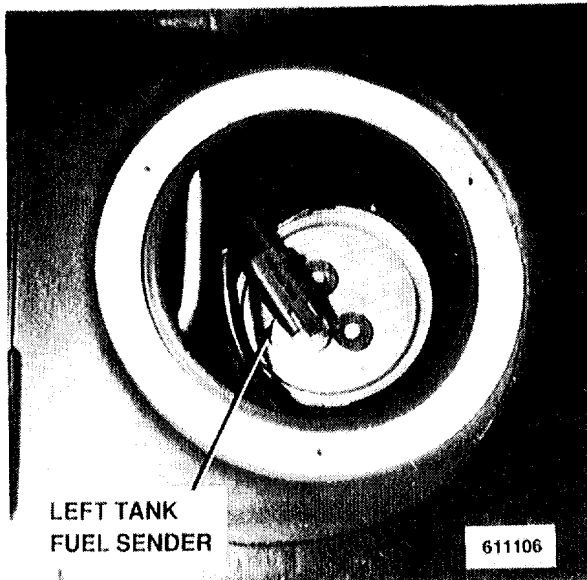

Figure 1 - Under LH Side of Rear Seat

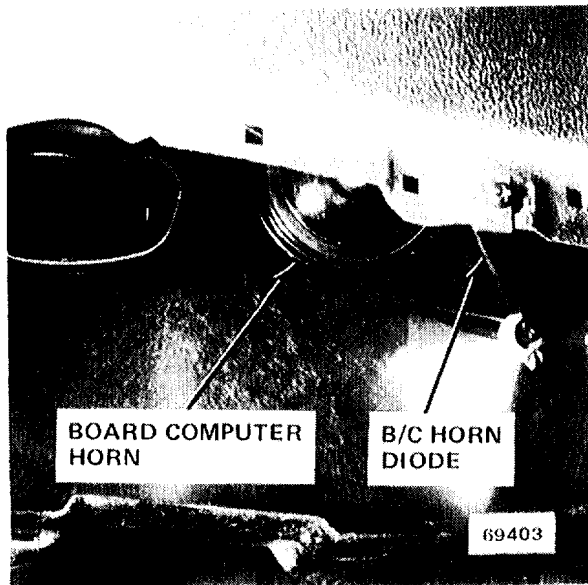

Figure 2 - Under LH Side of Front Bumper
(Splash Guard Pulled Down)

8000-0 SPLICE LOCATION VIEWS

INDEX

This index lists all the splices in the vehicle, the harness location of each splice, and the page on which each splice appears. The drawings after the index show how the harnesses are routed through the vehicle and the location of the splices on the harnesses.

SPLICE	HARNESS	PAGE NUMBER	SPLICE	HARNESS	PAGE NUMBER
S100	MAIN	8000-2	S219	INSTRUMENT PANEL	8000-5
S103	MAIN	8000-2	S221	INSTRUMENT PANEL	8000-5
S104	ENGINE	8000-3	S223	CRUISE CONTROL	NOT SHOWN
S105	ENGINE	8000-3	S224	MULTI- FUNCTION	NOT SHOWN
S106	ENGINE	8000-3	S225	MULTI- FUNCTION CLOCK	NOT SHOWN
S107	ENGINE	8000-3	S226	A/C	NOT SHOWN
S109	ENGINE	8000-3	S228	CRUISE CONTROL	NOT SHOWN
S111	ENGINE	8000-3	S229	AIR CONDITIONING	NOT SHOWN
S112	ENGINE	8000-3	S230	MAIN	8000-2
S113	ENGINE	8000-3	S231	MAIN	8000-2
S114	MAIN	8000-2	S232	MAIN	8000-2
S115	MAIN	8000-2	S233	MAIN	8000-2
S116	MAIN	8000-2	S234	MAIN	8000-2
S118	MAIN	8000-2	S235	MAIN	8000-2
S119	MAIN	8000-2	S236	MAIN	8000-2
S120	MAIN	8000-2	S237	MAIN	8000-2
S121	ENGINE	8000-3	S238	MAIN	NOT SHOWN
S201	ON-BOARD COMPUTER	8000-6			
S202	ON-BOARD COMPUTER	8000-6			
S207	MAIN	8000-2			
S209	MAIN	8000-2			
S210	MAIN	8000-2			
S211	MAIN	8000-2			
S212	MAIN	8000-2			
S213	MAIN	8000-2			
S215	MAIN	8000-2			

INDEX

SPLICE	HARNESS	PAGE NUMBER	SPLICE	HARNESS	PAGE NUMBER
S239	MAIN	8000-2	S330	MAIN	8000-2
S240	AIR	NOT	S332	DOOR	8000-4
	CONDITIONING	SHOWN	S333	DOOR	8000-4
S241	MAIN	8000-2	S340	MAIN	8000-2
S300	DOOR	8000-4	S341	MAIN	8000-2
S301	DOOR	8000-4	S342	DOOR	8000-4
S302	DOOR	8000-4	S345	RADIO	NOT
S303	DOOR	8000-4			SHOWN
S305	DOOR	8000-4	S400	RADIO	NOT
S306	INSTRUMENT				SHOWN
	PANEL	8000-5	S402	DOOR	8000-4
S307	INSTRUMENT		S403	RADIO	NOT
	PANEL	8000-5			SHOWN
S308	DOOR	8000-4	S404	RADIO	NOT
S309	DOOR	8000-4			SHOWN
S310	MAIN	8000-2	S411	DOOR	8000-4
S313	RADIO	NOT	S420	RADIO	NOT
		SHOWN			SHOWN
S316	MAIN	8000-2	S501	DOOR	8000-4
S319	MAIN	8000-2	S502	DOOR	8000-4
S322	DOOR	8000-4	S503	DOOR	8000-4
S323	DOOR	8000-4	S504	DOOR	8000-4
S324	MAIN	8000-2	S700	ENGINE	8000-3
S326	MAIN	8000-2	S701	ENGINE	8000-3
S329	MAIN	8000-2	S702	ENGINE	8000-3
			S704	ENGINE	8000-3

8000-2 SPlice LOCATION VIEWS

MAIN HARNESS SPlice LOCATIONS

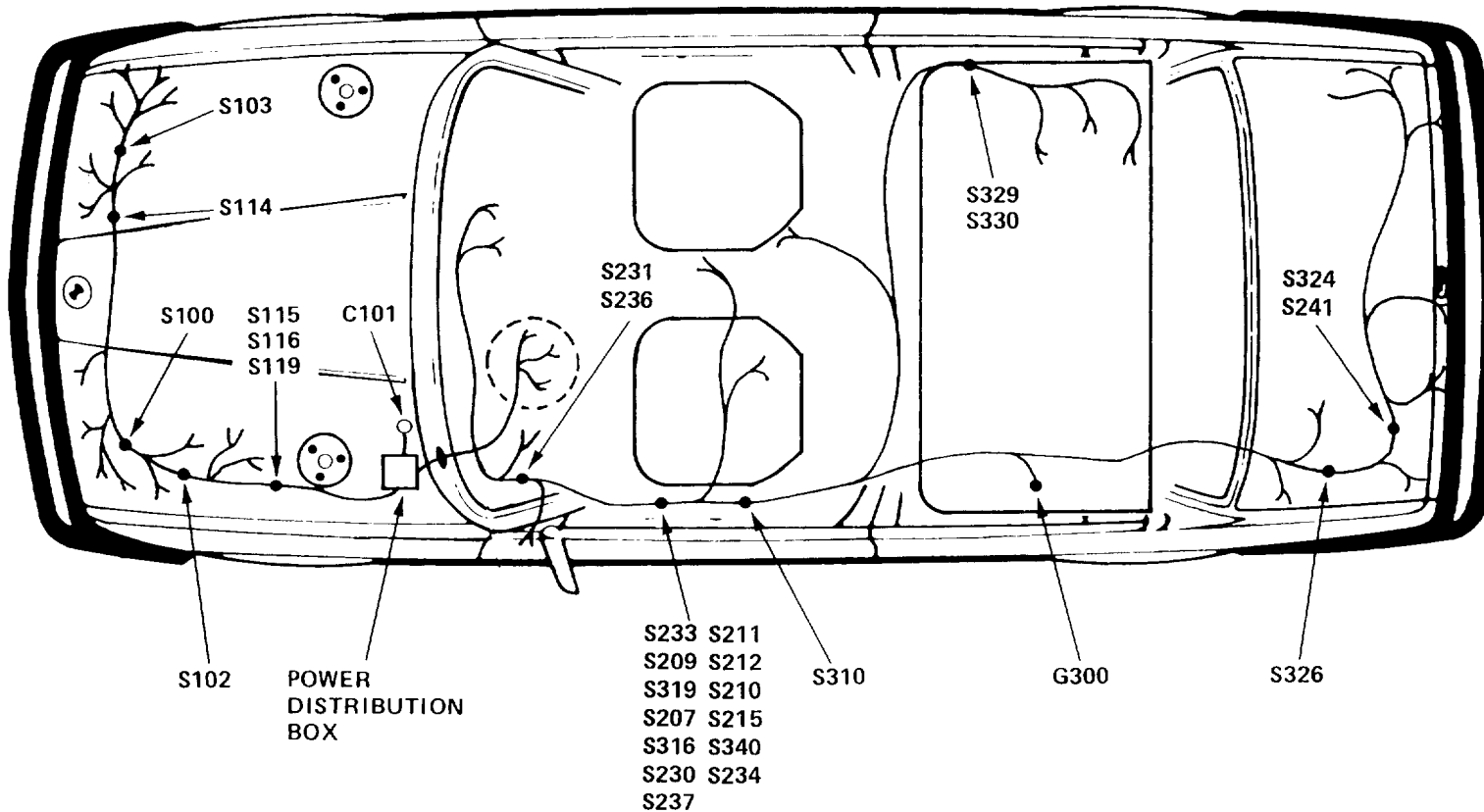
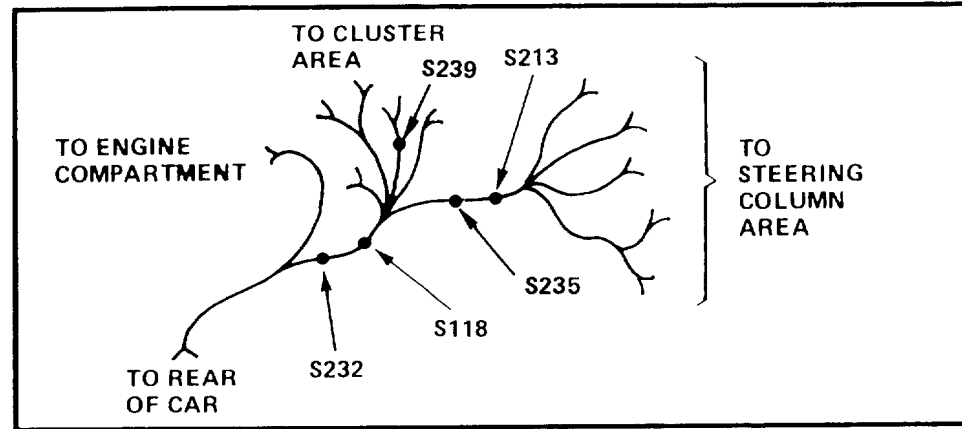

ENGINE HARNESS SPLICE LOCATIONS

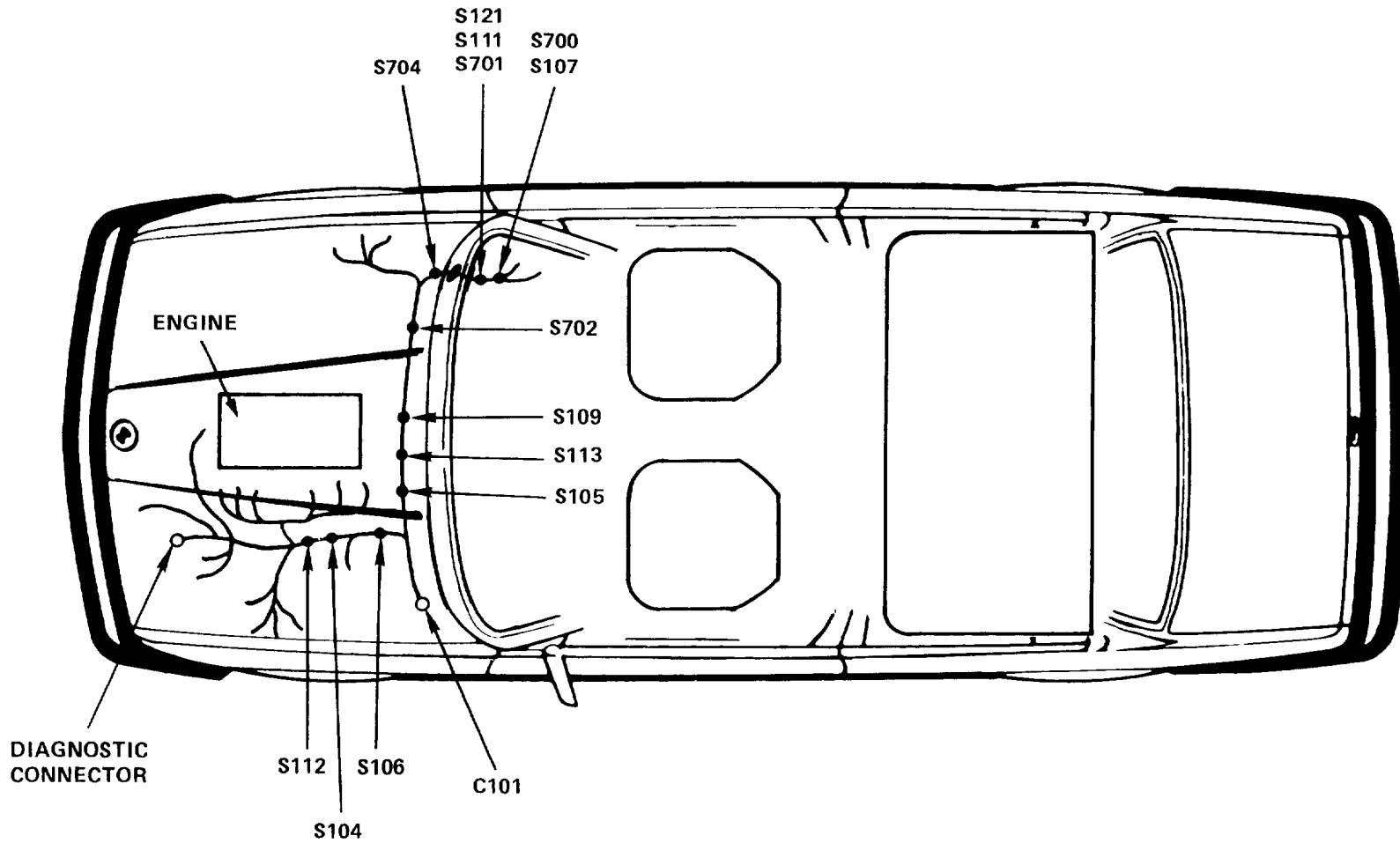

8000-4 SPLICE LOCATION VIEWS

DOOR HARNESS SPLICE LOCATIONS

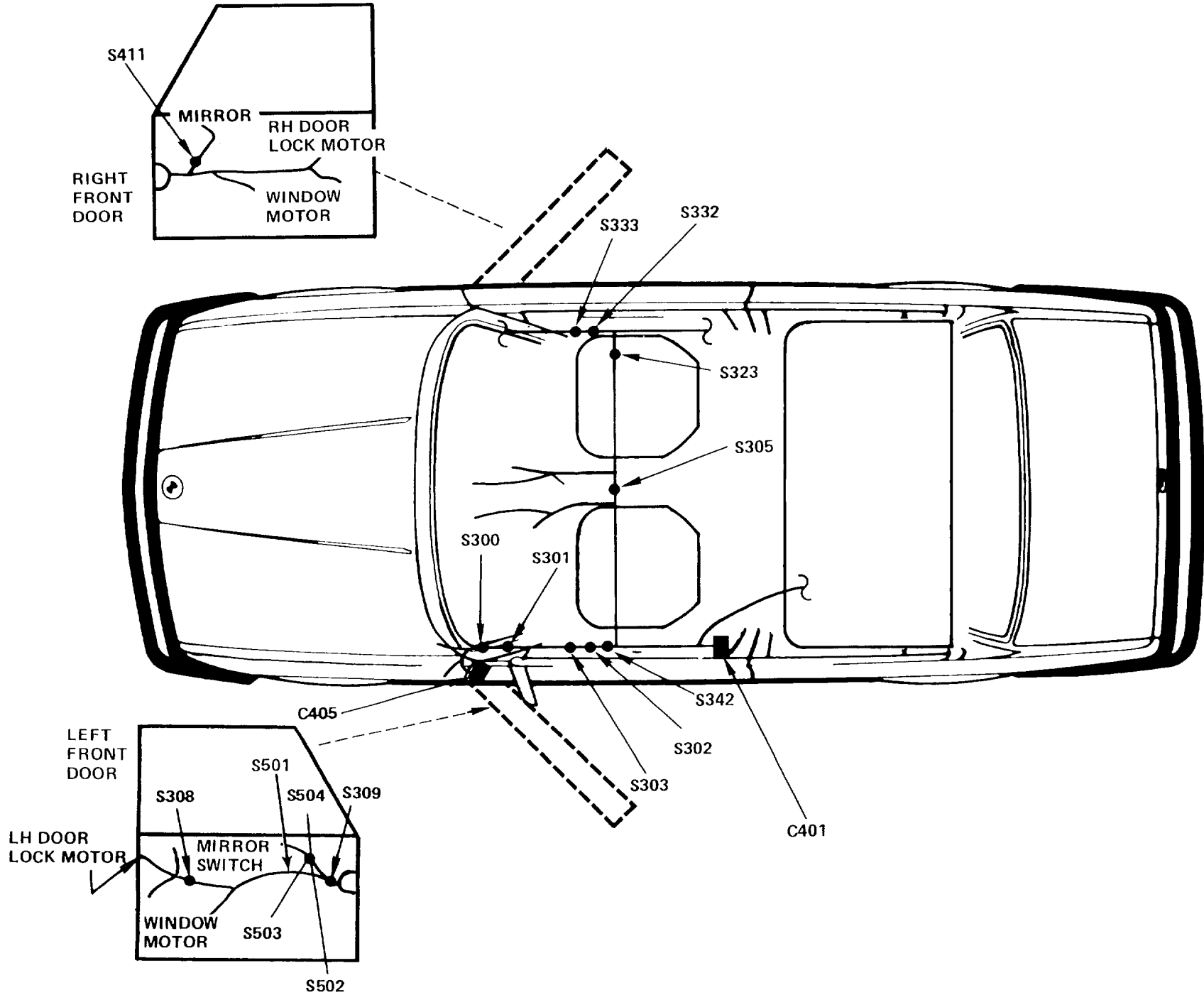

INSTRUMENT PANEL HARNESS SPLICE LOCATION

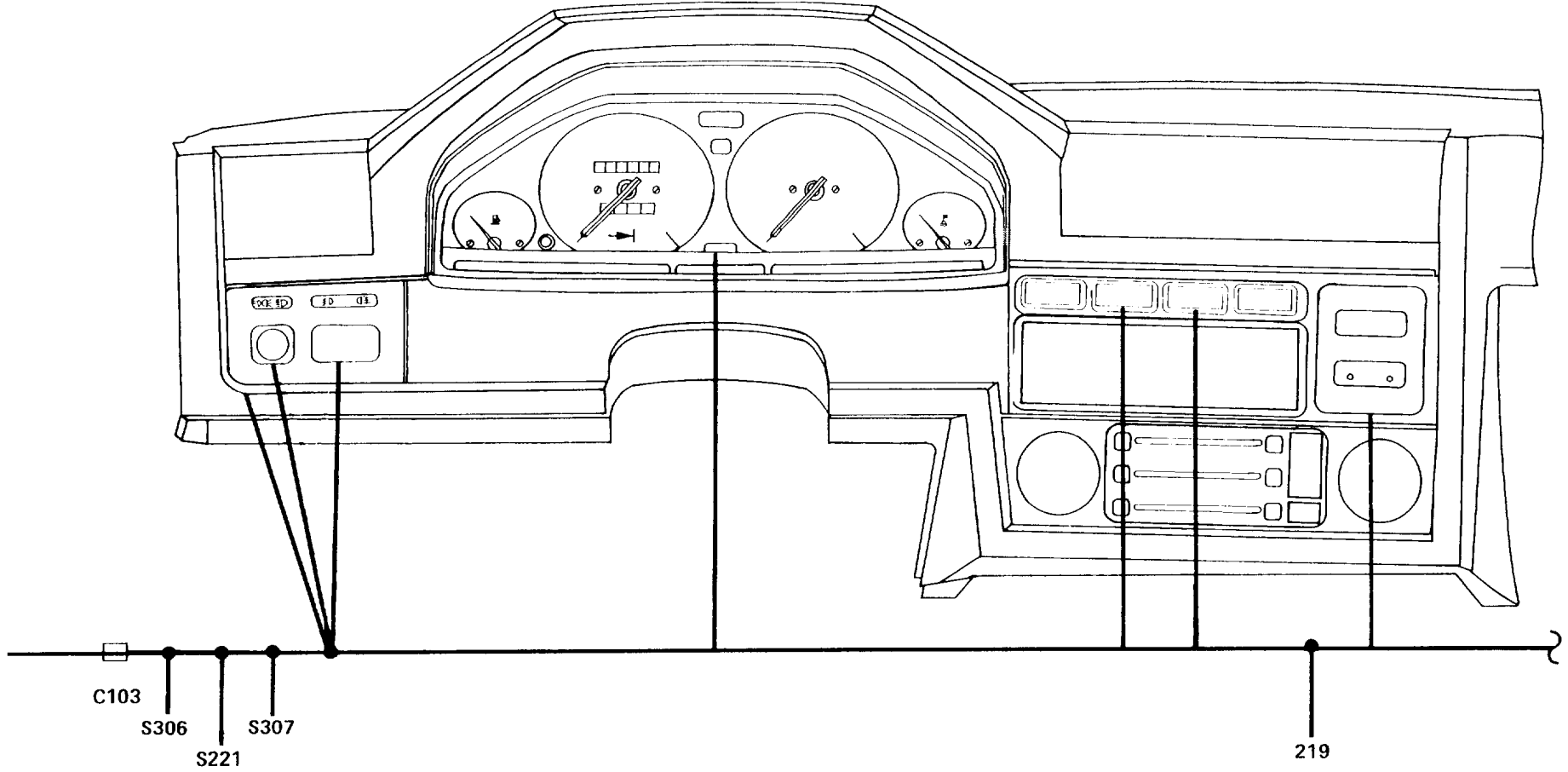

8000-6 SPLICE LOCATION VIEWS

ON-BOARD COMPUTER HARNESS SPLICE LOCATIONS

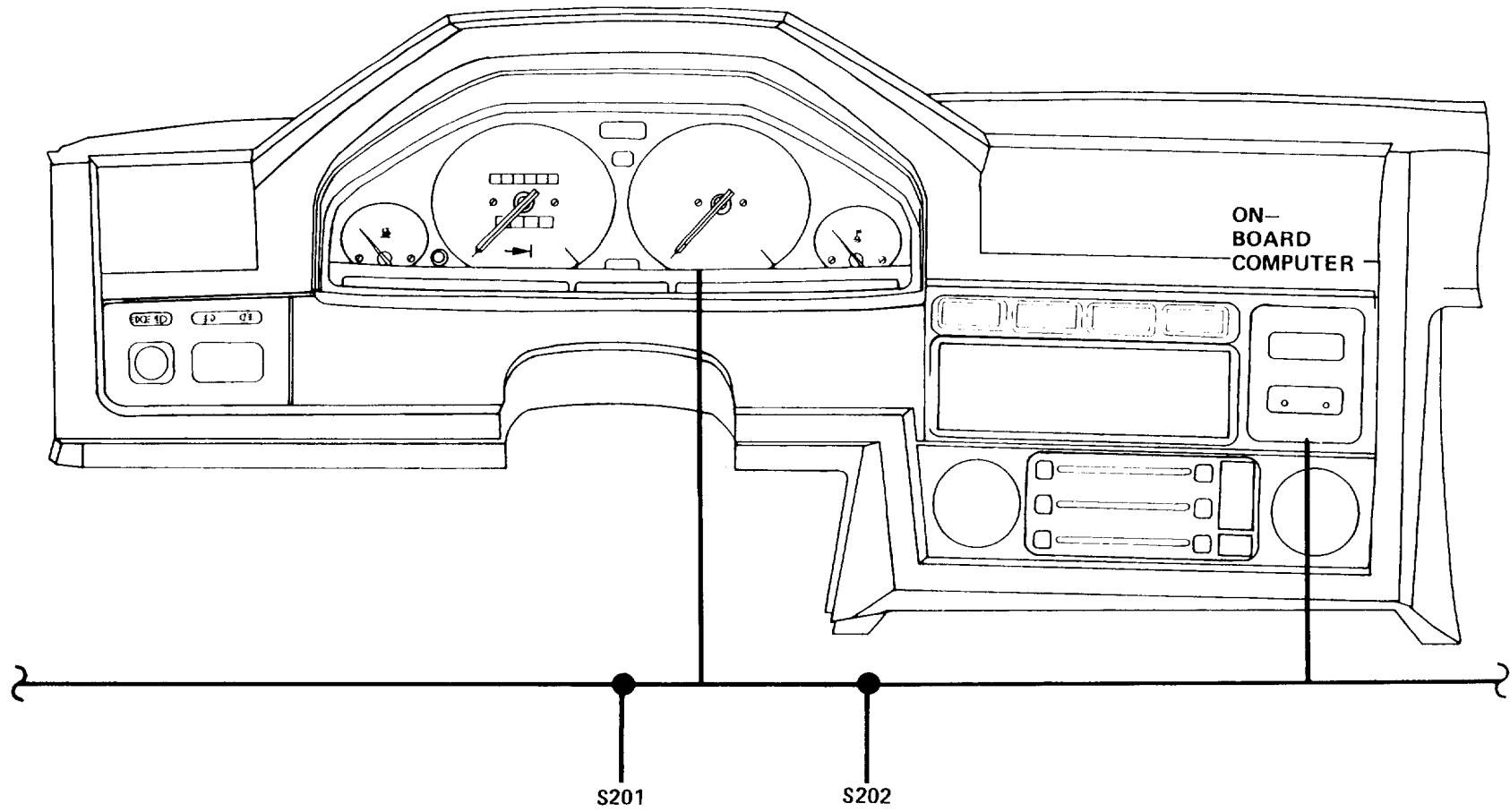

8500-0 CONNECTOR VIEWS

DIAGNOSTIC CONNECTOR

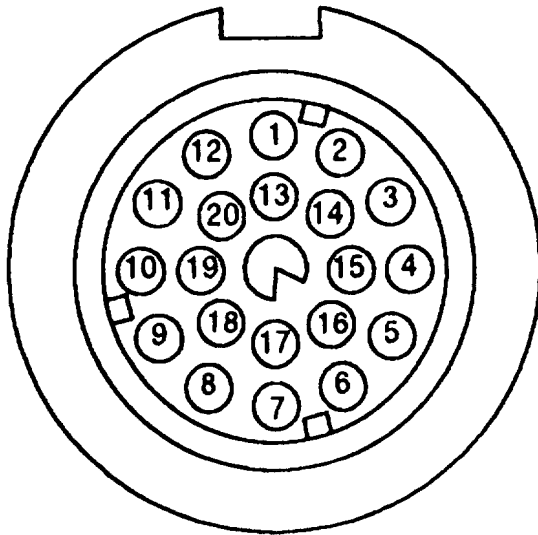

DIAGNOSTIC CONNECTOR FACE

Pin	Wire Size	Wire Color	Circuit and Component Connected
1	1	BK	Ignition Coil, Motronic Control Unit
6	.5	WT/BK	SRS Connector (Not Used)
7	.75	WT/GN	Service Interval Indicator, Service Interval Processor (Reset)
11	2.5	BK/YL	Starter, Start Signal (50)
12	.75	BU	Charge, Alternator (D+)
14	2.5	RD	Battery (+)
15	.5	WT/YL	Motronic Control Unit (RXD)
16	1.5	GN/WT	Oxygen Sensor
18	1.5	GN/BU	Motronic Control Unit (Programming Voltage)
19	1.5	BR	Ground Distribution (G103)
20	.5	WT/VI	Motronic Control Unit (TXD)

ACCESSORY CONNECTOR

CIRCUITS USING C302 (ACCESSORY CONNECTOR)

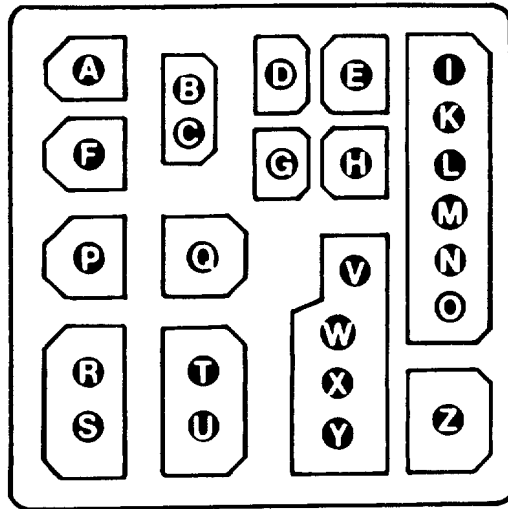
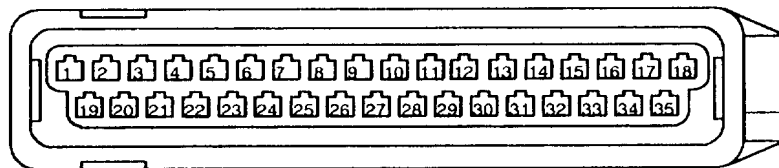

Figure 1-C302 (Accessory Connector)
Front View—Under LH Side
of Dash Ahead of Pedal Assembly

TERMINAL	CIRCUIT	TERMINAL	CIRCUIT
A	Not Used	N	Not Used
B	Not Used	O	Not Used
C	Not Used	P	Not Used
D	Central Locking	Q	Power Windows & Sunroof
E	Not Used	R	Cruise Control
F	Not Used	S	Anti-Lock Braking
G	Not Used	T	Not Used
H	On-Board Computer	U	Heated Seats
I	Not Used	V	Radio
J	Not Used	W	Radio
K	Not Used	X	Radio
L	Not Used	Y	Radio
M	Not Used	Z	Power Antenna

8500-2 CONNECTOR VIEWS

B350002



Mating Face
ABS CONTROL UNIT

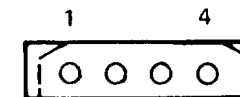

Wiring Face
BLOWER RESISTORS

B120014

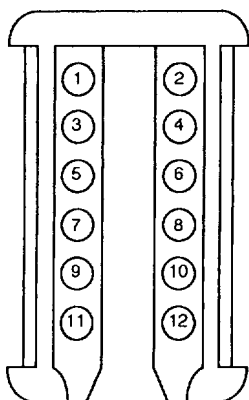

Wiring Face
ABS HYDRAULIC UNIT

B050010.00

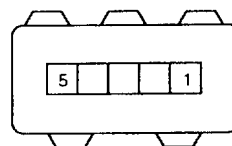

Mating Face
AIR FLOW METER

B080014

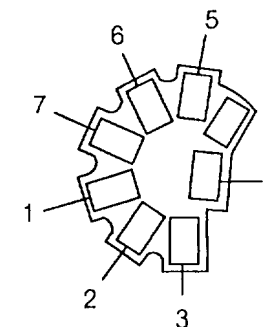

Wiring Face
BLOWER SPEED CONTROL

14 26

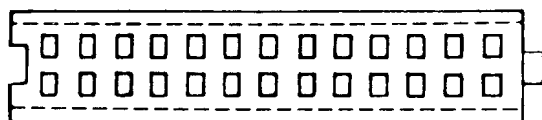

Wiring Face
ACTIVE CHECK CONTROL

B080012

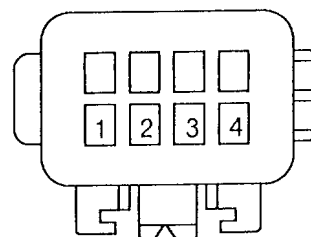

Wiring Face
AUXILIARY FUSE

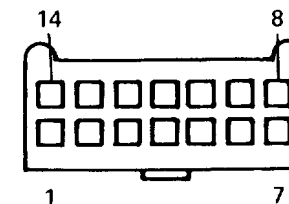

Wiring Face
CENTRAL LOCKING CONTROL UNIT

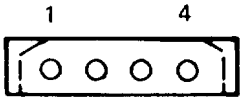

Wiring Face
CHIME MODULE (C1)

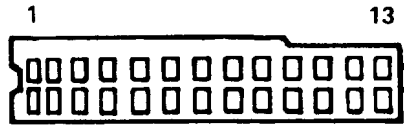

Wiring Face
CRUISE CONTROL

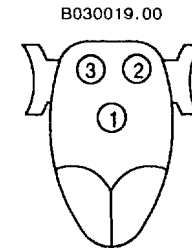

Wiring Face
DUAL TEMPERATURE SWITCH

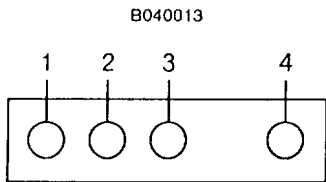

Wiring Face
CHIME MODULE (C2)

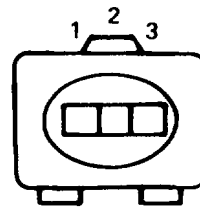

Mating Face
CYLINDER IDENTIFICATION SENSOR

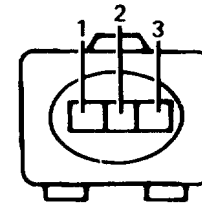

Wiring Face
ENGINE SPEED SENSOR

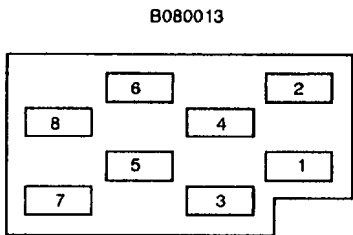

Wiring Face
CONTROL SWITCHES

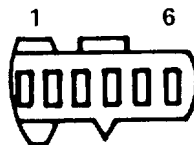

Wiring Face
DOOR LOCK MOTOR

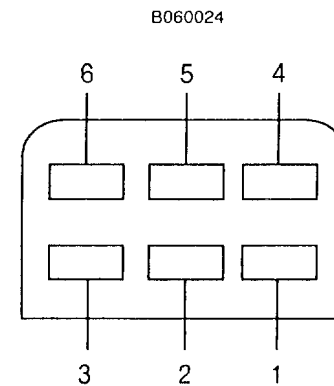

Wiring Face
EVAPORATOR TEMPERATURE REGULATOR

8500-4 CONNECTOR VIEWS

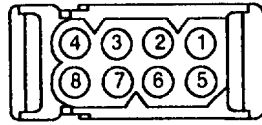

Mating Face
FADER CONTROL

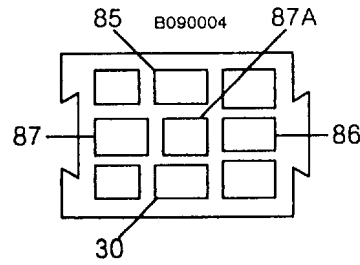

Wiring Face
FRESH/RECIRCULATING AIR RELAY

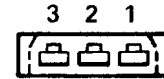

Wiring Face
FUEL TANK SENDER

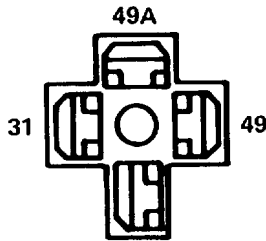

Wiring Face
FLASHER

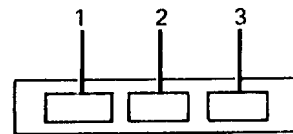

Wiring Face
FRONT TURN/PARK LIGHT

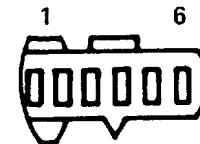

Wiring Face
GAS FILLER LOCK MOTOR

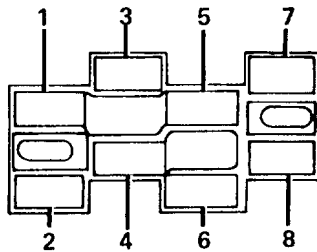

Wiring Face
FOG LIGHT SWITCH

B090001.13

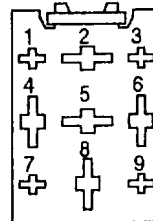

Wiring Face
FUEL PUMP RELAY

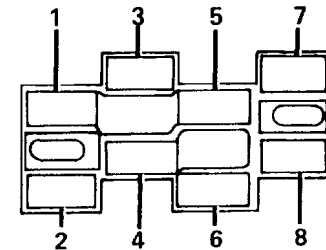

Wiring Face
HAZARD SWITCH

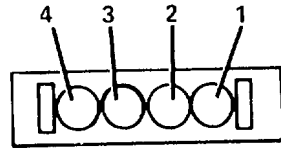

Wiring Face
HIGH LEVEL STOP LIGHT

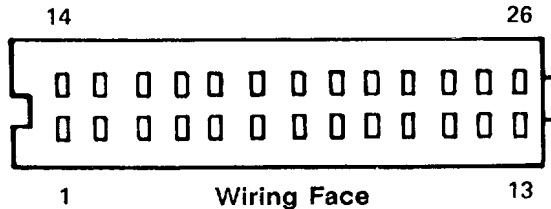

Wiring Face
INSTRUMENT CLUSTER (C1, C2)

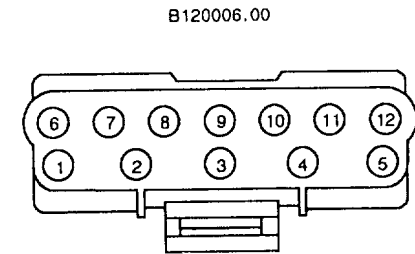

Wiring face
LIGHT SWITCH

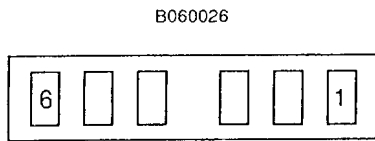

Wiring Face
HOT WATER CUT-OFF SWITCH

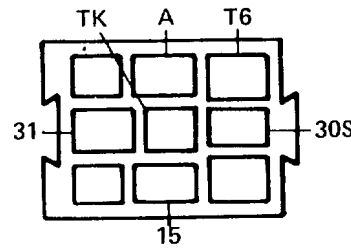

Wiring Face
INTERIOR LIGHT TIMER CONTROL

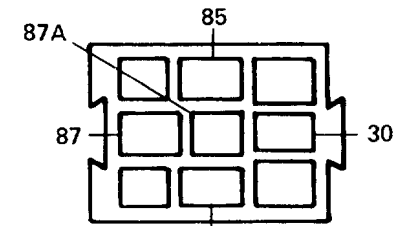

Wiring Face
MAIN RELAY

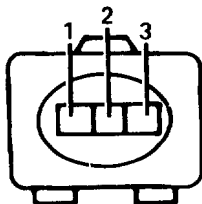

Wiring Face
IDLE SPEED ACTUATOR

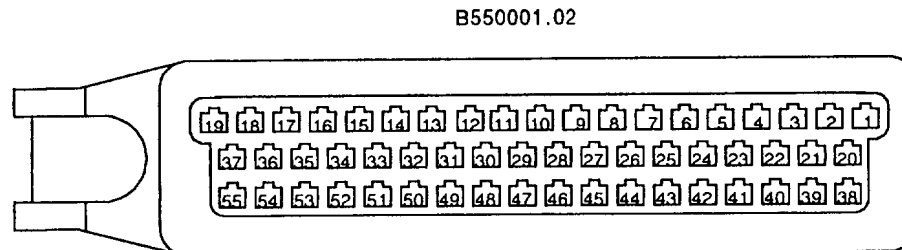

Mating Face
MOTRONIC CONTROL UNIT

8500-6 CONNECTOR VIEWS

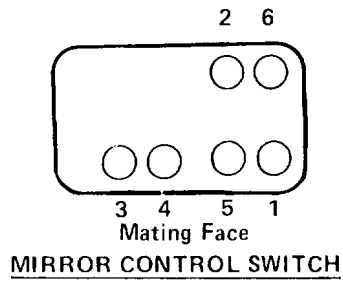

MIRROR CONTROL SWITCH

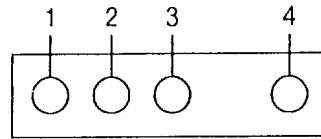

Wiring Face

ON-BOARD COMPUTER RELAY BOX

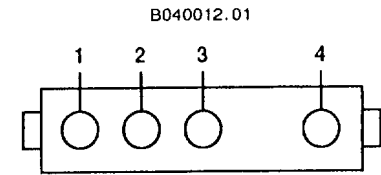

Wiring Face

POWER MIRRORS

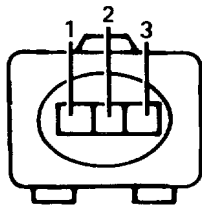

Wiring Face

OIL LEVEL SENSOR

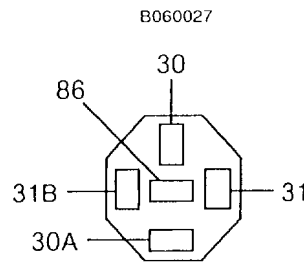

Wiring Face

OVER VOLTAGE PROTECTION RELAY

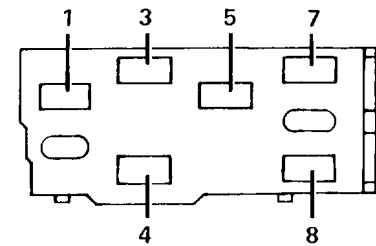

Wiring Face

POWER WINDOW SWITCHES

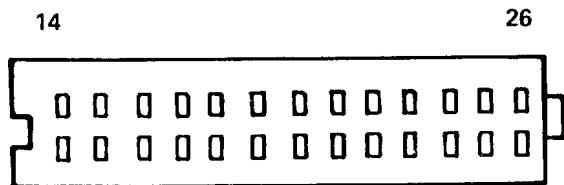

Wiring Face

ON-BOARD COMPUTER MODULE

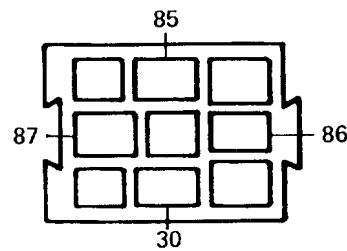

Wiring Face

OXYGEN SENSOR HEATER RELAY

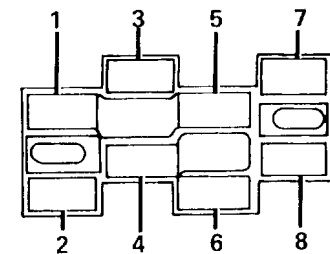

Wiring Face

REAR DEFOGGER SWITCH

B060027.00

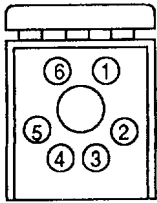

Wiring Face

REAR LIGHT ASSEMBLY

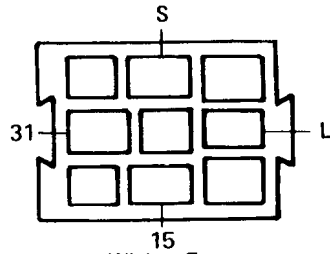

Wiring Face

SEAT BELT WARNING TIMER

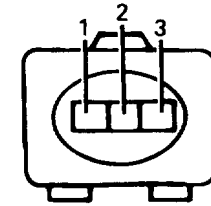

Wiring Face

THROTTLE SWITCH

B080015.01

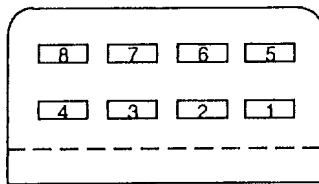

Wiring Face

REAR LIGHTS CHECK RELAY (C1)

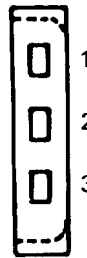

Wiring Face

SUNROOF MOTOR (CI)

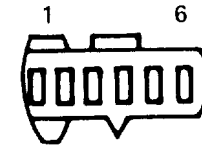

Wiring Face

TRUNK LID LOCK MOTOR

B060028 .01

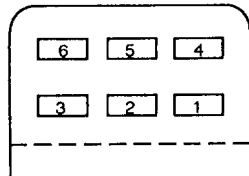

Wiring Face

REAR LIGHTS CHECK RELAY (C2)

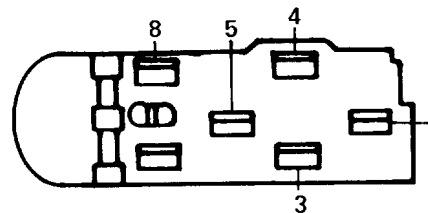

Wiring Face

SUNROOF SWITCH

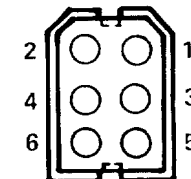

Wiring Face

C109

8500-8 CONNECTOR VIEWS

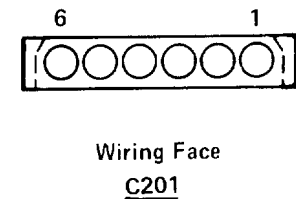
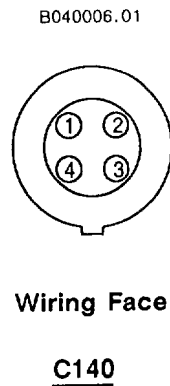
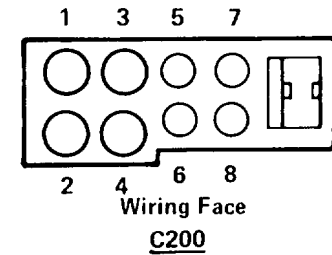
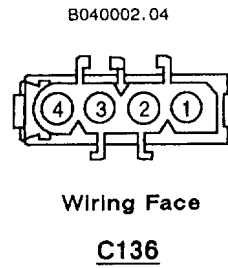
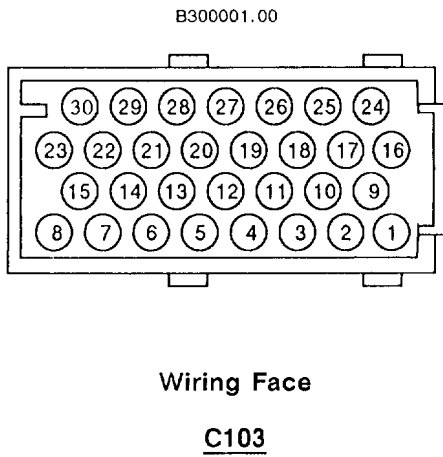
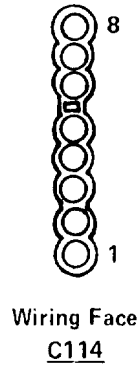
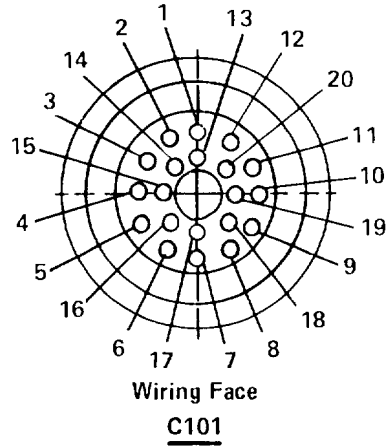

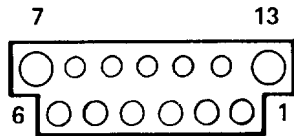

Wiring Face
C202

B070004.00

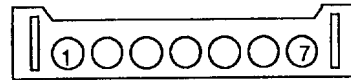

Wiring Face
C210

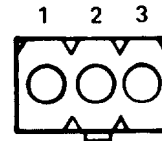

Wiring Face
C303
C304

B120002.06

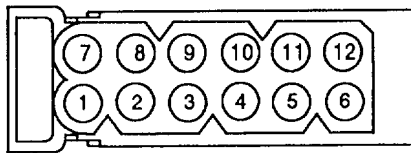

Wiring Face
C204

B060025

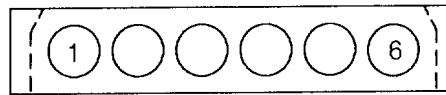

Wiring Face
C240

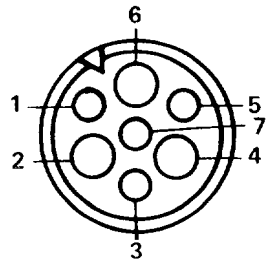

Wiring Face
C209

B060003.03

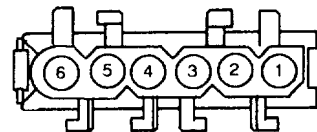

Mating Face
C242

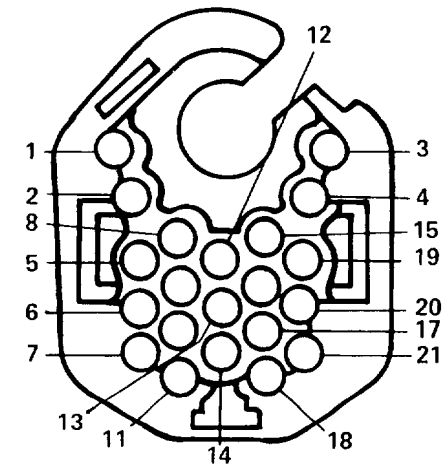

Wiring Face
C404
C405

9000-0 COMPONENT LOCATION CHART

COMPONENTS	Page-Figure
A/C In-Line Fuse	LH side of evaporator housing 7000-6-2
ABS Clutch Switch	Under LH side of dash, above clutch pedal 7000-4-3
ABS Electronic Control Unit	Under LH side of dash, above hood release. 7000-5-2
ABS Hydraulic Unit	In front of LH front wheel well 7000-0-3
Active Check Control Unit	Above rear view mirror 7000-6-6
Air Flow Meter	Behind air cleaner 7000-0-5
Amplifier	In trunk, above LH wheel well 7000-8-4
Auto-Charging Flashlight	In glove box. 7000-7-6
Automatic Transmission Range Switch.	At base of shift lever. 7000-7-1
Auxiliary Fan.	In front of radiator 7000-3-4
Auxiliary Fan Normal Speed Blower Resistor.	Front RH side of auxiliary fan 7000-3-4
Auxiliary Fuse.	On top of LH front shock tower 7000-0-1
B/C Horn Diode.	Above LH horn, behind splash guard 7000-9-2
Backup Light Switch	On transmission
Battery	In RH rear of trunk 7000-8-6
Battery Junction Block	Engine compartment at RH bulkhead 7000-1-5
Blower Motor	Behind cowl. 7000-2-2
Blower Resistors	Behind cowl, inside blower housing
Board Computer Horn	Above LH horn, behind splash guard 7000-9-2
Brake Fluid Level Switch.	Left of engine, on brake fluid reservoir. 7000-0-2
Brake Switch	On brake pedal support, above brake pedal. 7000-5-5
Brake Wear Sensors.	On LH front and RH rear brake calipers 7000-3-5
Central Locking Control Unit	Below and behind LH front speaker 7000-5-1
Chime Module.	Mounted on LH dash hush panel. 7000-5-6
Clutch Switch.	Above clutch pedal. 7000-4-3
Combination Switch	Upper LH side of steering column
Compressor Clutch Diode	Lower RH front of engine, on compressor. 7000-2-3
Coolant Level Switch	In front of LH front wheel well, in coolant reservoir . 7000-0-6
Coolant Temperature Sender.	Front of engine, top of thermostat housing. 7000-1-2
Coolant Temperature Sensor.	Front of engine, top of thermostat housing. 7000-1-2
Cruise Control Actuator	Forward of LH front shock tower 7000-0-6
Cruise Control Unit	Mounted under RH side of dash 7000-7-3
Cylinder Identification Sensor	On ignition wire, at distributor 7000-3-1
Deceleration Sensor.	Behind LH front shock tower 7000-0-1
Diagnostic Connector.	Top LH front of engine 7000-2-5
Door Lock Motors	Rear part of each door
Driver Exterior Door Handle Switch.	In rear of LH front door
Dual Temperature Switch	Top LH side of radiator 7000-1-3
Engine Speed Sensor	Lower RH front of engine. 7000-2-6

COMPONENTS	Page-Figure
Evaporative Purge Valve	Below LH side of throttle body 7000-3-2
Evaporator Temperature Regulator	Under LH side of dash, near evaporator 7000-6-3
Evaporator Temperature Sensor	On LH side of evaporator housing 7000-6-3
Flasher	Upper part of steering column 7000-6-1
Fresh/Recirculating Air Flap Door Motors	Behind A/C face plate 7000-6-2
Fresh/Recirculating Air Relays	Behind A/C face plate
Fuel Injectors	Below intake manifold, at each port. 7000-1-2
Fuel Pump Relay	On bracket, in front of LH front shock tower. 7000-0-5
Fuel Tank Sender	Top of fuel tank 7000-8-2
Fusible Link A	In RH rear of trunk
Gas Filler Lock Motor	In trunk, behind RH wheel well 7000-8-6
Hazard Switch	In center console, above radio 7000-6-5
High Pressure Cut-Out Switch	On receiver dryer, behind RH headlight 7000-1-4
Horn Brush/Slip Ring	In upper steering column 7000-6-1
Horns	Near fog lights, behind splash guard 7000-3-3
Hot Water Cut-Off Switch	Under LH side of dash, near evaporator 7000-6-2
Idle Speed Actuator	LH top of engine. 7000-2-5
Ignition Coil	On RH front wheel well 7000-1-4
Ignition Key Switch	Part of ignition switch, in upper part of steering column
Ignition Switch	Upper part of steering column 7000-6-1
Interior Light Timer Control	Below LH front speaker 7000-5-1
Left Tank Fuel Sender	Under LH side of rear seat 7000-9-1
Low Pressure Cut-Out Switch	Behind RH headlights 7000-1-4
Main Fuel Pump	In fuel tank 7000-8-2
Main Relay	On bracket in front of LH front shock tower 7000-0-5
Motor Relay	In windshield header, above rear view mirror 7000-6-6
Motronic Control Unit	Under RH side of dash, above glove box 7000-7-3
Oil Level Sensor	Top LH side of oil pan 7000-0-4
Oil Pressure Switch	Below oil filter 7000-2-4
On-Board Computer Module	In center console, on RH side of radio 7000-6-5
On-Board Computer Relay Box	Under LH side of dash, above hood release. 7000-5-5
Oscillating Plate Compressor Clutch	Lower RH front of engine, on compressor. 7000-2-3
Outside Temperature Sensor	Behind splash guard, near LH fog light 7000-3-3
Over Voltage Protection Relay	Under LH side of dash, near ABS Electronic Control Unit 7000-5-2
Oxygen Sensor	Lower RH rear of engine compartment. 7000-2-1
Oxygen Sensor Heater Relay	On bracket, in front of LH front shock tower. 7000-0-5
Park Brake Switch	At base of parking brake 7000-7-2

9000-2 COMPONENT LOCATION CHART

COMPONENTS		Page-Figure
Power Antenna	In trunk, behind LH wheel well	7000-8-3
Power Distribution Box	At top rear of LH front wheel well	7000-0-1
Power Window Circuit Breaker	On center console, above radio	7000-7-1
Power Window Motors	Forward part of each door	7000-3-6
Pulse Wheels	On wheel, in brake housing	
Rear Lights Check Relay	In trunk, above LH wheel well	7000-8-4
RH Front Door Micro-Switch	In rear of RH front door	
Rotary Compressor Clutch	Lower RH front of engine, on compressor.	7000-2-3
Safety Switch	On top of LH wheel well, near cruise control actuator	
Seatbelt Switch	In driver's seatbelt buckle	
Seatbelt Warning Timer	Under LH side of dash, on electrical bracket	7000-5-6
Speed Detectors	On wheel, in brake housing	7000-1-6
Speedometer Sender	In rear of differential	7000-4-4
Start Relay	Upper LH corner of driver's footwell	7000-5-6
Starter	Lower LH rear of engine	7000-1-1
Sunroof Motor	In windshield header, above rear view mirror	7000-6-6
Throttle Switch	Below LH side of throttle body	7000-3-2
Trunk Lid Lock Motor	On trunk lock center support	7000-8-5
Unlock Inhibit Switch	Rear of LH front door	
Washer Fluid Level Switch	In reservoir, behind RH front shock tower.	7000-1-5
Washer Pump	Behind RH front shock tower, on reservoir	7000-1-5
Water Shut-Off Solenoid	LH side of evaporator housing	7000-6-2
Wiper Motor	Under LH fresh air intake cowl	7000-2-2

CONNECTORS

Page-Figure

C101 (20 pins)	Next to power distribution box, mounted on engine dash	7000-0-2
C102	LH rear of engine compartment	
C103 (29 pins)	Behind LH side of dash, on body electrical bracket	7000-5-4
C104 (3 pins)	Under LH side of dash	7000-6-3
C109 (6 pins)	Near wiper motor	
C110	RH front of engine compartment	7000-1-4
C113 (3 pins)	Behind LH headlights	7000-0-3
C126 (2 pins)	Behind LH headlights	7000-0-3
C127 (2 pins)	Behind RH headlights	
C128 (2 pins)	Behind RH front side marker light	
C129 (2 pins)	Behind LH front side marker light	
C131 (1 pin)	Behind RH side of dash, above glove box	7000-7-3
C136	Under RH side of dash	7000-7-3
C140 (3 pins)	Near RH rear side of engine	7000-2-1
C142 (1 pin)	Under LH side of dash, near steering column	7000-6-4
C143 (1 pin)	Under LH side of dash, near body electrical bracket	7000-5-6
C150 (2 pins)	On top of LH front wheel well	7000-0-5
C151 (2 pins)	On top of RH front wheel well	7000-1-4
C190	Under RH side of rear seat	7000-8-2
C191	Lower LH side of engine	7000-1-1
C200 (9 pins)	Under LH side of dash, on steering column	7000-6-4
C201 (6 pins)	Under LH side of dash, on steering column	7000-6-4
C202 (13 pins)	Under LH side of dash, on steering column	7000-6-4
C204 (12 pins)	Under LH side of dash, near steering column	7000-6-3
C208 (2 pins)	Near brake pedal support bracket	7000-5-6
C209 (7 pins)	Above brake pedal	7000-5-3
C210 (4 pins)	On LH side of steering column	7000-6-4
C215 (2 pins)	Center console, behind radio	7000-6-5
C217 (2 pins)	Under LH side of dash, near accessory connector	7000-5-4
C219 (2 pins)	In trunk, above LH wheel well	7000-8-3
C233 (2 pins)	Behind center of dash	7000-6-5
C240 (6 pins)	Under LH side of dash, above body electrical bracket	7000-5-3
C260 (2 pins)	Behind LH side of dash	7000-5-3
C301 (2 pins)	At base of shift lever	7000-7-1
C302 (25 pins) Accessory Connector	Upper LH corner of driver's footwell	7000-5-4
C303 (3 pins)	At base of RH "B" pillar	7000-7-5
C304 (3 pins)	At base of LH "B" pillar	7000-7-4
C305 (1 pin)	Under LH side of dash, near accessory connector	7000-5-3
C306	In center console	7000-7-1

9000-4 COMPONENT LOCATION CHART

		Page-Figure
C351 (1 pin)	Under LH side of dash, near accessory connector . .	7000-5-3
C352 (2 pins)	Behind LH side of rear seat	7000-8-1
C360 (2 pins)	Behind RH side of rear seat	7000-8-2
C404 (21 pins)	Above RH front door jamb switch	7000-4-2
C405 (21 pins)	Above LH front door jamb switch	7000-4-1
C406	Below RH front speaker	7000-4-6
C407	Below LH front speaker	7000-4-5
C421	Under RH front seat	
C422	Under LH front seat	
C503 (3 pins)	In rear of LH front door	
C510 (1 pin)	Behind and above LH front speaker	7000-5-1
GROUNDS		
G100	RH rear of trunk, behind battery	7000-8-6
G103	Behind RH shock tower	7000-1-5
G104	On inner fender, behind LH headlights	7000-0-6
G106	In trunk, near LH wheel well	7000-8-4
G200	Under LH side of dash, above brake pedal	7000-5-5
G201 (Steering Column Ground)	Upper LH side of steering column	7000-6-1
G300	Behind LH side of rear seat	7000-8-1
G302	In trunk, behind LH wheel well	7000-8-3
G600	In windshield header	
